

FRANKE



KOLEK CIJA

2025/2026





SADRŽAJ

Uvod	4
Korita od nehrđajućeg čelika	06
Sudoperi od nehrđajućeg čelika	46
Korita od fragranita	58
Sudoperi od fragranita	76
Sudoperi Tectonite®	94
Sudoperi od keramike	98
Dodatni pribor sudoperi	104
Obrada vode	112
Slavine od nehrđajućeg čelika	124
Slavine	132
Dodatni pribor slavine	148
Sorteri otpada	150

Materijal dizajniran da zadovolji svačiji ukus!

Antracit



Zlatna



Bakrena



F-Inox tehnologija

Ekskluzivni Franke premaz koji skuplja kapljice vode i na taj način omogućuje sušenje sudopera bez mrlja i tragova. Vodoodbojan i otporan na ogrebotine, ovaj futuristički premaz ne boji se ni topline do 100°. Formula istinske i trajne ljepote koju možete cijeniti u našoj kolekciji Masterpiece.



Nehrđajući
čelik



Nehrđajući čelik

Bilo da više volite reflektirajuću kvalitetu polirane završne obrade ili elegantan izgled brušene završne obrade, koja daje više mat sjaja, postoji rješenje za vas u našem asortimanu proizvoda od nehrđajućeg čelika. Svi elementi izrađeni su od visokokvalitetnog čelika, vrlo otpornog na mrlje, hrđu i koroziju. Ako je nehrđajući čelik jedan od najpopularnijih materijala u kuhinji, to je s dobrim razlogom.

Crna mat



Crna



Kameno siva



Aluminij



Bijela



Kašmir



Avena



Sahara

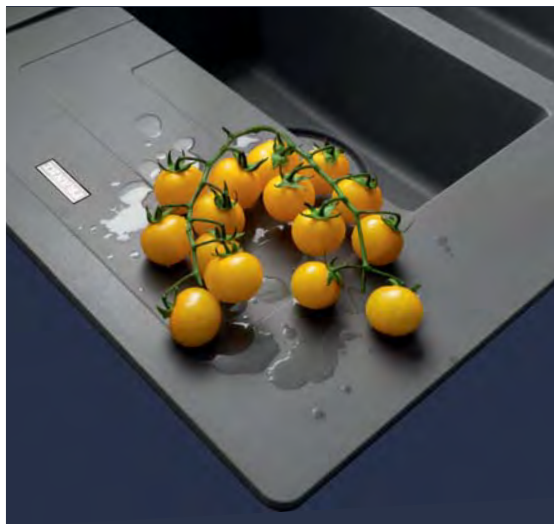

Fragranit

Izuzetno otporan materijal, vrlo otporan na toplinu, deformacije, ogrebotine i mrlje. Jedinstveni materijal koji je razvio Franke ima suptilan sjaj i, s 80 % udjela granita, nudi topao osjećaj.

Fragranit tretiran sa Sanitized® također smanjuje rast bakterija i mikroba za 99% - što je vrlo važno svojstvo za naše kuhinje, jer se bakterije mogu razmnožavati svakih 20 minuta, čineći kuhinjske površine vrlo nehigijenskim.

Sjajni ili mat; glatki ili kameni efekt, ekstra jak ili super trendi. Vaša kuhinja može puno reći o vama, stoga je svaki detalj bitan. Kako bismo vam pružili priliku da stvorite svoju savršenu kuhinju, naš asortiman materijala dizajniran je da zadovolji svaki ukus, odgovara svakom stilu i izdrži sve napore.

Otkrijte jedinstvene značajke i prednosti svakog materijala i odaberite onaj koji vam se najviše sviđa i koji najbolje odgovara vašim potrebama.

Tectonite®

Franke Tectonite izrađen je od naprednog sintetičkog kompozitnog materijala. Njegov izgled nalik granitu i jedinstvena tekstura ne samo da izgledaju impresivno u vašoj kuhinji, već čine sudoper otpornim na toplinu i ogrebotine. Iako je materijal lagan, izdržava udarce i opterećenja koja se mogu dogoditi tijekom svakodnevnog upotrebe u kuhinji.

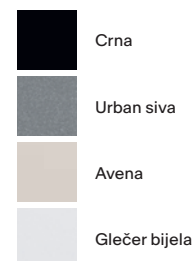

Keramika

Keramika je prirodni materijal koji se koristi stoljećima, posebno u okruženju s visokim zahtjevima, dokazane higijene i čistoće. Prirodan izgled visoke kvalitete osmišljen posebno za patentiranu keramiku Fraceram® je u savršenom skladu s kamenom ili drvom. Zahvaljujući posebnom načinu pripreme, Franke keramički sudoperi imaju elegantan dizajn i površinu laku za čišćenje.

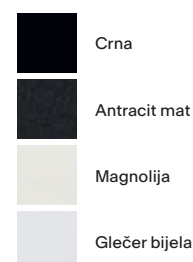
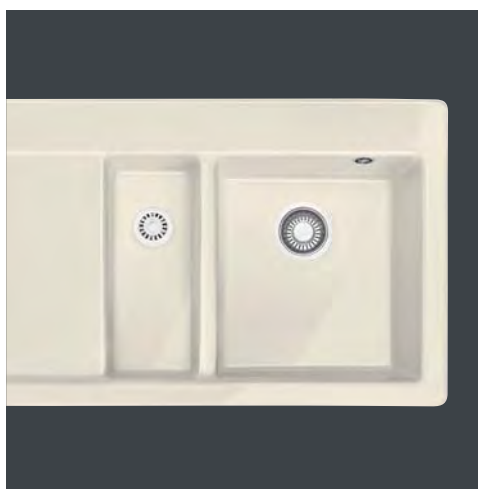

PVD premaz

PVD, ili "Physical Vapor Deposition", tehnologija je premaza koja može učiniti slavine još otpornijima na abraziju, ogrebotine i koroziju te nudi iznimne estetske karakteristike. Slavina tretirana PVD premazom također je otporna na UV zrake i čini manje vidljivim otiske prstiju koji se neizbježno stvaraju u kuhinji. Birajte između crne, bakrene, antracit ili zlatne i stvorite jedinstveno okruženje.

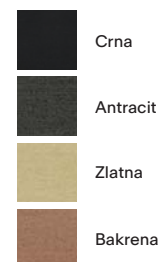

Korita od nehrđ



nehrđajućeg



čelika

Korita od nehrđajućeg čelika

Univerzalna ugradnja



NOVO

Masterpiece Premium
BXM 210/110-68
725 x 450 mm
str. 12



NOVO

Masterpiece
BXM 210/110-40
440 x 450 mm
str. 13



NOVO

Masterpiece
BXM 210/110-50
540 x 450 mm
str. 14



NOVO

Masterpiece
BXM 210/110-68
725 x 450 mm
str. 15



Box
BXX 210/110-34
380 x 450 mm
str. 33



Box
BXX 210/110-40
440 x 450 mm
str. 33



Box
BXX 210/110-45
490 x 450 mm
str. 33



Box
BXX 210/110-50
540 x 450 mm
str. 33



Box
BXX 210/110-68
725 x 450 mm
str. 33



Box
BXX 220/120 34-34
740 x 450 mm
str. 33

Standardna ugradnja



Bell
BCX 610-51
510 x 510 mm
str. 43



Bell
BCX 610-81
810 x 510 mm
str. 43



NOVO

Spark
SKN 610-37
455 x 435 mm
str. 44



NOVO

Rotondo
ROX 610-39
Ø 510 mm
str. 45

Kolekcija Masterpiece - slavine i dozatori tekućeg deterdženta



NOVO

Masterpiece
Doccia
str. 16



NOVO

Eos Neo
Doccia
str. 17



NOVO

Eos Neo
str. 17



NOVO

Atlas Neo
Doccia
str. 18



NOVO

Atlas Neo
str. 18



NOVO

Atlas
Dozator tekućeg deterdženta
str. 19

Poravnana / poluporavnana ugradnja

Ugradnja pod radnu ploču



Box Center
BWX 220-54-27
860 x 510 mm
str. 26



Box Center
BWX 220-41-27
790 x 510 mm
str. 26



Mythos
MYX 210-34
352 x 412 mm
str. 29



Mythos
MYX 210-45
462 x 412 mm
str. 29



Mythos
MYX 210-50
512 x 412 mm
str. 30



Mythos
MYX 210-55
562 x 412 mm
str. 30



Mythos
MYX 210-70
712 x 412 mm
str. 30



Box
BXX 210-40 TL
430 x 510 mm
str. 34



Box
BXX 210-50 TL
530 x 510 mm
str. 34



Box
BXX 210-54 TL
570 x 510 mm
str. 34



Box
BXX 220 36-36 TL
770 x 510 mm
str. 34



Planar
PPX 210-58 TL
580 x 512 mm
str. 35



Maris
MRX 210-34
380 x 440 mm
str. 36



Maris
MRX 210-40
540 x 450 mm
str. 36



Maris
MRX 210-40 TL
430 x 510 mm
str. 36



Maris
MRX 210-45
490 x 440 mm
str. 37



Maris
MRX 210-50
540 x 440 mm
str. 37



Maris
MRX 210-50 TL
530 x 510 mm
str. 37



Maris
MRX 210-70
740 x 440 mm
str. 37



Maris
MRX 210-70 TL
730 x 510 mm
str. 37



Smart
SRX 210-40 TL
430 x 510 mm
str. 42



Smart
SRX 210-50 TL
530 x 510 mm
str. 42

NOVO



Maris Quiet
MQX 110-50
500 x 400 mm
str. 23

NOVO



Maris Quiet
MQX 110-82
820 x 424 mm
str. 23



Box Center
BWX 120-41-27
820 x 520 mm
str. 27



Mythos
MYX 110-16
200 x 440 mm
str. 31



Mythos
MYX 110-34
380 x 440 mm
str. 31



Mythos
MYX 110-45
490 x 440 mm
str. 31



Mythos
MYX 110-50
540 x 440 mm
str. 31



Mythos
MYX 110-55
590 x 440 mm
str. 31



Mythos
MYX 110-70
740 x 440 mm
str. 31



Planar
PPX 110-52
560 x 450 mm
str. 35



Maris
MRX 110-34
380 x 440 mm
str. 37



Maris
MRX 110-40
440 x 440 mm
str. 38



Maris
MRX 110-45
490 x 440 mm
str. 38



Maris
MRX 110-50
540 x 440 mm
str. 38



Maris
MRX 110-55
590 x 440 mm
str. 38



Maris
MRX 110-70
740 x 440 mm
str. 38



Maris
MRX 160-34-19
595 x 440 mm
str. 38



Aton
ANX 110-34
370 x 430 mm
str. 39



Aton
ANX 110-48
510 x 430 mm
str. 39



Aton
AMX 120
770 x 450 mm
str. 39



Sottotop
AMX 160
530 x 400 mm
str. 40



Sottotop
AMX 120
715 x 400 mm
str. 40



Sottotop
GAX 110-30
332 x 372 mm
str. 41



Sottotop
SVX 110-40
428 x 428 mm
str. 41



Sottotop
GAX 110-45
482 x 432 mm
str. 41

Masterpiece kolekcija



Dajte svom domu elegantan i profinjen izgled odabirom jedne od izvanrednih metalik boja naše kolekcije Masterpiece. Širok i precizan izbor sudopera, slavina, dozatora za sapun i pribora čiji su detalji estetski i kvalitativno savršeni za jedinstvenu i osebujnu kuhinju.

Kolekcija Masterpiece sastoji se od velikog izbora sudopera, slavina i dodataka, a svi su izrađeni od najkvalitetnijih materijala. Osmišljen kako bi vašu kuhinju pretvorio u pravo umjetničko djelo, također će vam olakšati svakodnevni život.



Masterpiece slavina s tušem

Nova slavina Masterpiece nije samo lijepa, već je i nevjerovatno funkcionalna: glava tuša s dvostrukim mlazom i laminarnim aeratorom super je učinkovita za pranje čak i najtvrdokornije prljavštine i za lako doseganje bilo koje točke Masterpiece velikog korita, osiguravajući maksimalnu udobnost.

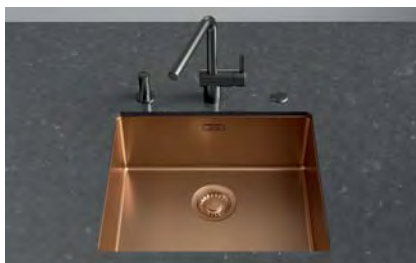
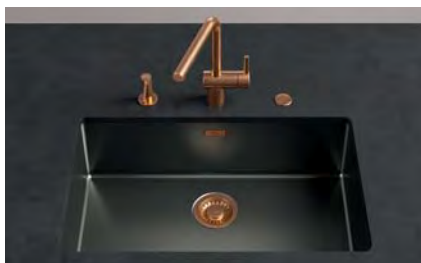

Dozator tekućeg deterdženta Atlas

Upotpunite sudoper kombiniranjem različitih komponenti u istoj nijansi ili stvaranjem originalne kombinacije



PUSH-PULL
daljinski otvarač
pilete



Skriveni
preljevnik



Rozeta



Daljinski otvarač
pilete za drobilicu
otpada Air Switch



Otvor za drobilicu
otpada

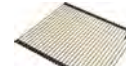

Rollmat
podloška



Kadica/cjedilo
inox

Ekskluzivno za Masterpiece sudopere



Jednostavan
za čišćenje



Dugotrajan



Otporan na visoku
temperaturu



Otkrijte F-Inox, ekskluzivni Franke premaz koji čini površinu sudopera hidrofobnom za čišćenje bez tragova. F-Inox također poboljšava otpornost na ogrebotine i ne boji se kipuće vode. Prava dugotrajna formula ljepote dostupna na svim Masterpiece sudoperima.

Masterpiece premium



Masterpiece - Premium paket elegantno, prepoznatljivo i moderno

Za još prepoznatljiviji izgled, kolekcija Masterpiece također nudi Premium paket koji donosi dodatnu praktičnost: praktičnu rešetku koja postaje ocjeđivač za suđe u kombinaciji s rollmat podlogom za zaštitu od vrućine, daskom za rezanje i perforiranom kadicom za pripremu vašeg jela.

Koju god opciju odabrali, kolekcija Masterpiece Premium odražava jedan od najelegantnijih i najmodernijih dizajnerskih trendova današnjice.

MASTERPIECE PREMIUM - BXM 210/110-68 - univerzalna ugradnja



NOVO

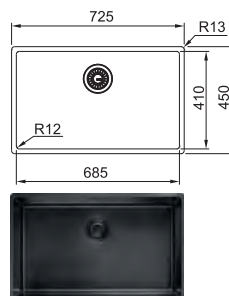
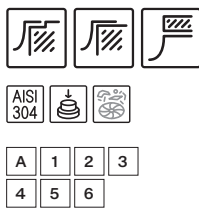

Završna obrada
Antracit
FUN broj
127.0676.885

Ormar
Dimenzije Š x D
800 mm
725 x 450 mm
Ugradni otvor Š x D
vidi uputu
Dubina korita
200 mm
Rub
slim top

MASTERPIECE PREMIUM

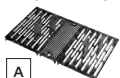

112.0676.895
Rešetka/ocjeđivač za dno sudopera Premium Pack



112.0676.854
Ploča za rezanje Hygenia Premium Pack



112.0655.239
Kadica/cjedilo inox antracit



112.0655.341
Kadica/cjedilo inox bakar

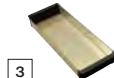

112.0655.240
Kadica/cjedilo inox boja zlata

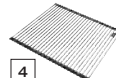

112.0655.342
Rollmat podloška antracit

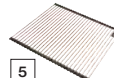

112.0655.344
Rollmat podloška bakar

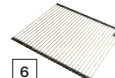

112.0655.343
Rollmat podloška boja zlata

Masterpiece



F INOX
TECHNOLOGY

MASTERPIECE - BXM 210/110-40 - univerzalna ugradnja



NOVO

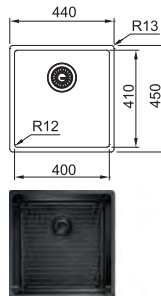
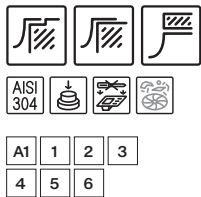

Završna obrada	FUN broj
Antracit	127.0650.362
Ormar	450 mm
Ormar ako je podugradnja	500 mm
Dimenzije Š x D	440 x 450 mm
Ugradni otvor Š x D	vidi uputu
Dubina korita	200 mm
Rub	slim top

MASTERPIECE - BXM 210/110-40 - univerzalna ugradnja



NOVO

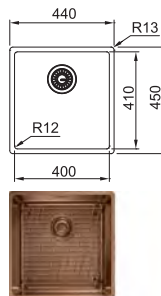

Završna obrada	FUN broj
Bakrena	127.0662.649
Ormar	450 mm
Ormar ako je podugradnja	500 mm
Dimenzije Š x D	440 x 450 mm
Ugradni otvor Š x D	vidi uputu
Dubina korita	200 mm
Rub	slim top

MASTERPIECE - BXM 210/110-40 - univerzalna ugradnja



NOVO

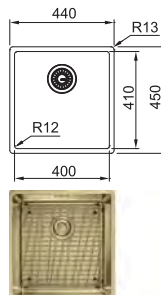

Završna obrada	FUN broj
Zlatna	127.0662.648
Ormar	450 mm
Ormar ako je podugradnja	500 mm
Dimenzije Š x D	440 x 450 mm
Ugradni otvor Š x D	vidi uputu
Dubina korita	200 mm
Rub	slim top

MASTERPIECE s daljinskim upravljačem

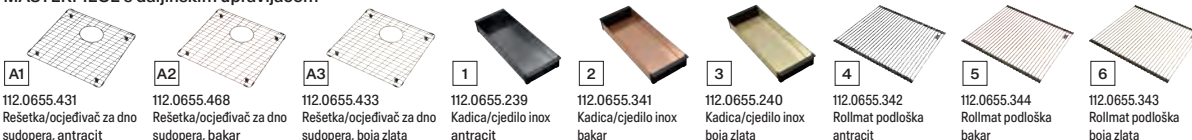

A1
112.0655.431
Rešetka/ocjeđivač za dno sudopera, antracit

A2
112.0655.468
Rešetka/ocjeđivač za dno sudopera, bakar

A3
112.0655.433
Rešetka/ocjeđivač za dno sudopera, boja zlata

1
112.0655.239
Kadica/cjedilo inox antracit

2
112.0655.341
Kadica/cjedilo inox bakar

3
112.0655.240
Kadica/cjedilo inox boja zlata

4
112.0655.342
Rollmat podloška antracit

5
112.0655.344
Rollmat podloška bakar

6
112.0655.343
Rollmat podloška boja zlata



F INOX
TECHNOLOGY

MASTERPIECE - BXM 210/110-50 - univerzalna ugradnja



NOVO

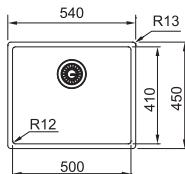

Završna obrada	FUN broj
Antracit	127.0650.363
Ormar	550 mm
Ormar ako je podugradnja	600 mm
Dimenzije Š x D	540 x 450 mm
Ugradni otvor Š x D	vidi uputu
Dubina korita	200 mm
Rub	slim top

MASTERPIECE - BXM 210/110-50 - univerzalna ugradnja



NOVO

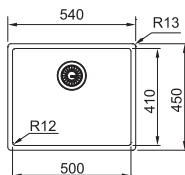

Završna obrada	FUN broj
Bakrena	127.0662.642
Ormar	550 mm
Ormar ako je podugradnja	600 mm
Dimenzije Š x D	540 x 450 mm
Ugradni otvor Š x D	vidi uputu
Dubina korita	200 mm
Rub	slim top

MASTERPIECE - BXM 210/110-50 - univerzalna ugradnja



NOVO

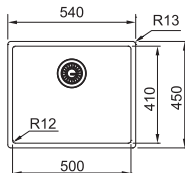

Završna obrada	FUN broj
Zlatna	127.0662.540
Ormar	550 mm
Ormar ako je podugradnja	600 mm
Dimenzije Š x D	540 x 450 mm
Ugradni otvor Š x D	vidi uputu
Dubina korita	200 mm
Rub	slim top

MASTERPIECE s daljinskim upravljačem

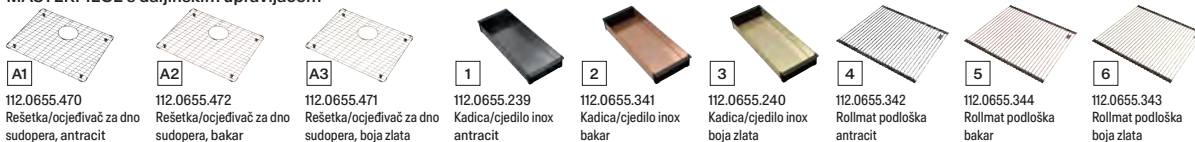



F INOX
TECHNOLOGY

MASTERPIECE - BXM 210/110-68 - univerzalna ugradnja



NOVO

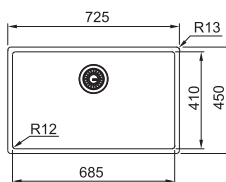

Završna obrada	FUN broj
Antracit	127.0650.364
Ormar	800 mm
Dimenzije Š x D	725 x 450 mm
Ugradni otvor Š x D	vidi uputu
Dubina korita	200 mm
Rub	slim top

MASTERPIECE - BXM 210/110-68 - univerzalna ugradnja



NOVO

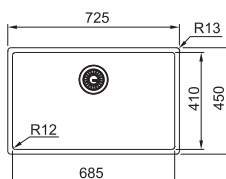

Završna obrada	FUN broj
Bakrena	127.0662.644
Ormar	800 mm
Dimenzije Š x D	725 x 450 mm
Ugradni otvor Š x D	vidi uputu
Dubina korita	200 mm
Rub	slim top

MASTERPIECE - BXM 210/110-68 - univerzalna ugradnja



NOVO

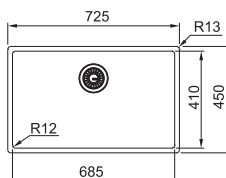

Završna obrada	FUN broj
Zlatna	127.0662.643
Ormar	800 mm
Dimenzije Š x D	725 x 450 mm
Ugradni otvor Š x D	vidi uputu
Dubina korita	200 mm
Rub	slim top

MASTERPIECE s daljinskim upravljačem

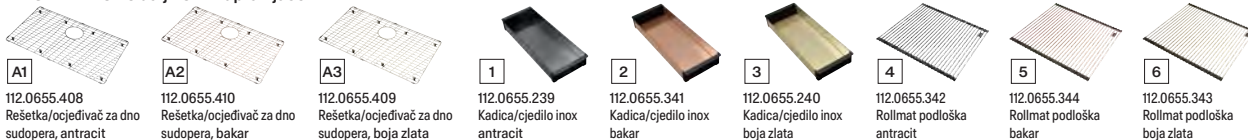

A1
112.0655.408
Rešetka/ocjeđivač za dno sudopera, antracit

A2
112.0655.410
Rešetka/ocjeđivač za dno sudopera, bakar

A3
112.0655.409
Rešetka/ocjeđivač za dno sudopera, boja zlata

1
112.0655.239
Kadica/cjedilo inox antracit

2
112.0655.341
Kadica/cjedilo inox bakar

3
112.0655.240
Kadica/cjedilo inox boja zlata

4
112.0655.342
Rollmat podloška antracit

5
112.0655.344
Rollmat podloška bakar

6
112.0655.343
Rollmat podloška boja zlata

Masterpiece Doccia



MASTERPIECE DOCCIA



NOVO

PVD

AISI 304

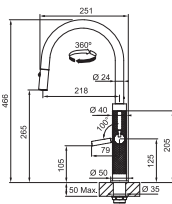

360°

Završna obrada
Antracit masivni
nehrđajući čelik
FUN broj
115.0711.555

MASTERPIECE DOCCIA



NOVO

PVD

AISI 304

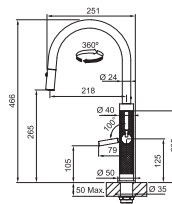

360°

Završna obrada
Bakreni masivni
nehrđajući čelik
FUN broj
115.0711.557

MASTERPIECE DOCCIA



NOVO

PVD

AISI 304

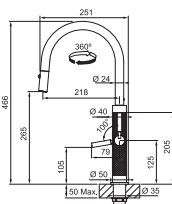

360°

Završna obrada
Zlatni masivni
nehrđajući čelik
FUN broj
115.0711.558

MASTERPIECE DOCCIA



NOVO

AISI 304

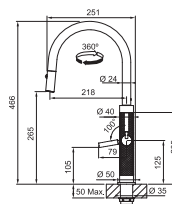

360°

Završna obrada
Masivni
nehrđajući čelik
FUN broj
115.0711.554

Eos Neo



EOS NEO DOCCIA



NOVO

PVD

AISI 304

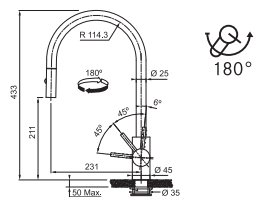

Završna obrada	FUN broj
Antracit masivni nehrđajući čelik	115.0628.256
Bakreni masivni nehrđajući čelik	115.0628.254
Zlatni masivni nehrđajući čelik	115.0681.244

EOS NEO



NOVO

PVD

AISI 304

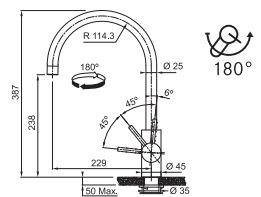

Završna obrada	FUN broj
Antracit masivni nehrđajući čelik	115.0628.253
Bakreni masivni nehrđajući čelik	115.0628.251
Zlatni masivni nehrđajući čelik	115.0681.243

Atlas Neo



ATLAS NEO DOCCIA

ATLAS NEO



NOVO

PVD

AISI 304

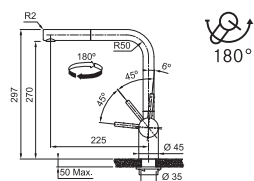

Završna obrada	FUN broj
Antracit masivni nehrđajući čelik	115.0628.210
Bakreni masivni nehrđajući čelik	115.0628.208
Zlatni masivni nehrđajući čelik	115.0681.242



NOVO

PVD

AISI 304

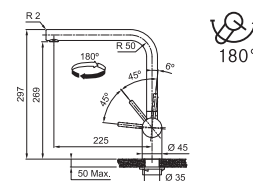

Završna obrada	FUN broj
Antracit masivni nehrđajući čelik	115.0628.207
Bakreni masivni nehrđajući čelik	115.0628.204
Zlatni masivni nehrđajući čelik	115.0681.241

Atlas Dozator



DOZATOR TEKUĆEG DETERDŽENTA ATLAS

DOZATOR TEKUĆEG DETERDŽENTA ATLAS

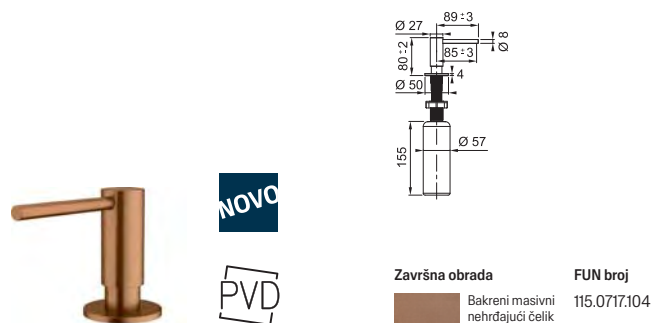
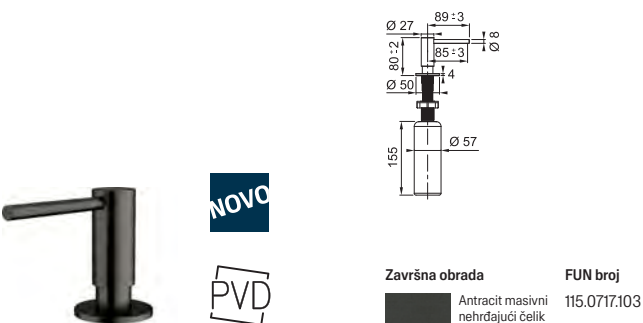

DOZATOR TEKUĆEG DETERDŽENTA ATLAS

DOZATOR TEKUĆEG DETERDŽENTA ATLAS

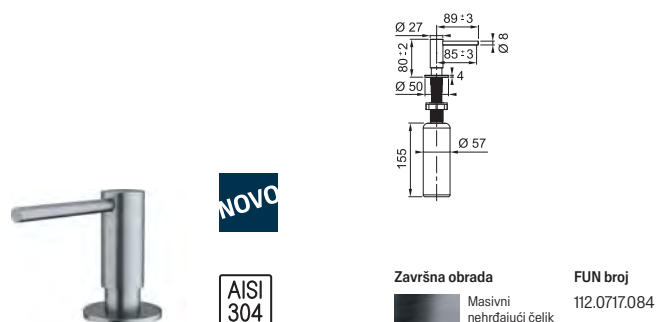
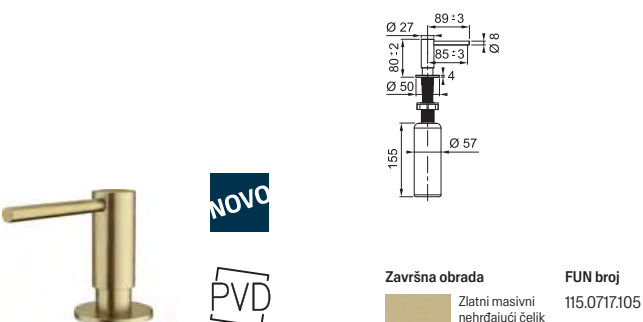

Model	Korito BXM 210/110-40 400mm	Korito BXM 210/110-50 500mm	Korito BXM 210/110-68 685mm
--------------	-----------------------------------	-----------------------------------	-----------------------------------

Model	Slavina Masterpiece Doccia	Slavina Atlas Neo	Slavina Atlas Neo Doccia	Slavina Eos Neo	Slavina Eos Neo Doccia
--------------	-------------------------------	----------------------	--------------------------------	--------------------	------------------------------

Antracit



FUN + Korito s daljinskim otvaračem pilete*	127.0650.362	127.0650.363	127.0650.364
---	--------------	--------------	--------------

FUN	115.0711.555	115.0628.207	115.0628.210	15.0628.253	115.0628.256
------------	--------------	--------------	--------------	-------------	--------------

Bakrena



FUN + Korito s daljinskim otvaračem pilete*	127.0662.649	127.0662.642	127.0662.644
---	--------------	--------------	--------------

FUN	115.0711.557	115.0628.204	115.0628.208	15.0628.251	115.0628.254
------------	--------------	--------------	--------------	-------------	--------------

Zlatna



FUN + Korito s daljinskim otvaračem pilete*	127.0662.648	127.0662.540	127.0662.643
---	--------------	--------------	--------------

FUN	115.0711.558	115.0681.241	115.0681.242	15.0681.243	115.0681.244
------------	--------------	--------------	--------------	-------------	--------------

*uključuje donju rešetku iste boje

Model	Dozator deterdženta Atlas	Skriveni preljevnik	Daljinski otvarač pilete Push-Pull	Set odvoda automatski	Set odvoda manualni	Air Switch aktivator drobilicu otpada	Set odvoda za drobilicu otpada	Rollmat podloška	Kadica/cjedilo inox	Ploča za rezanje
-------	---------------------------	---------------------	------------------------------------	-----------------------	---------------------	---------------------------------------	--------------------------------	------------------	---------------------	------------------

Antracit



FUN	112.0717.103	112.0630.204	112.0630.187	112.0629.967	112.0630.933	112.0664.346	112.0664.350	112.0655.342	112.0655.239	112.0676.854
-----	--------------	--------------	--------------	--------------	--------------	--------------	--------------	--------------	--------------	--------------

Bakrena



FUN	112.0717.104	112.0630.186	112.0630.188	112.0629.956	112.0630.983	112.0664.348	112.0664.394	112.0655.344	112.0655.341	112.0676.854
-----	--------------	--------------	--------------	--------------	--------------	--------------	--------------	--------------	--------------	--------------

Zlatna



FUN	112.0717.105	112.0630.208	112.0630.210	112.0629.887	112.0630.934	112.0664.347	112.0664.391	112.0655.343	112.0655.240	112.0676.854
-----	--------------	--------------	--------------	--------------	--------------	--------------	--------------	--------------	--------------	--------------

Sudoperi se isporučuju u kompletu s odvodnom jedinicom i sifonom

Maris Quiet

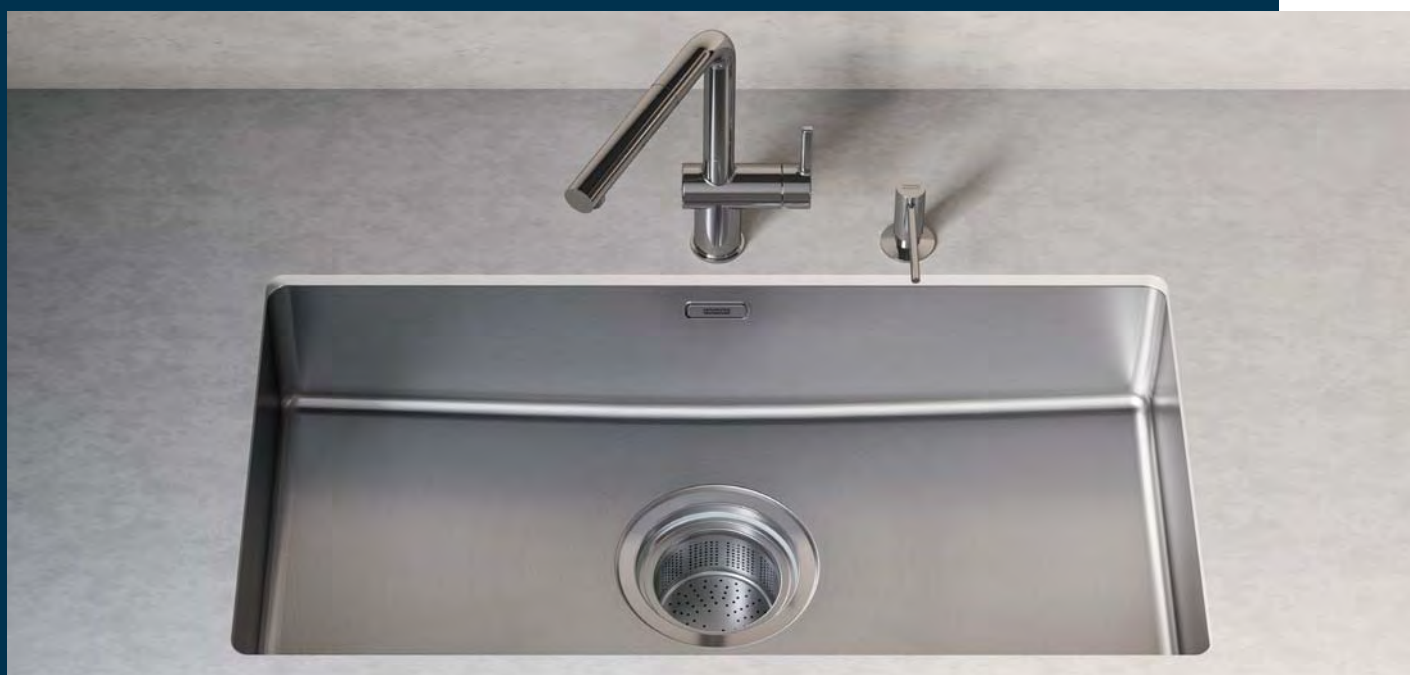
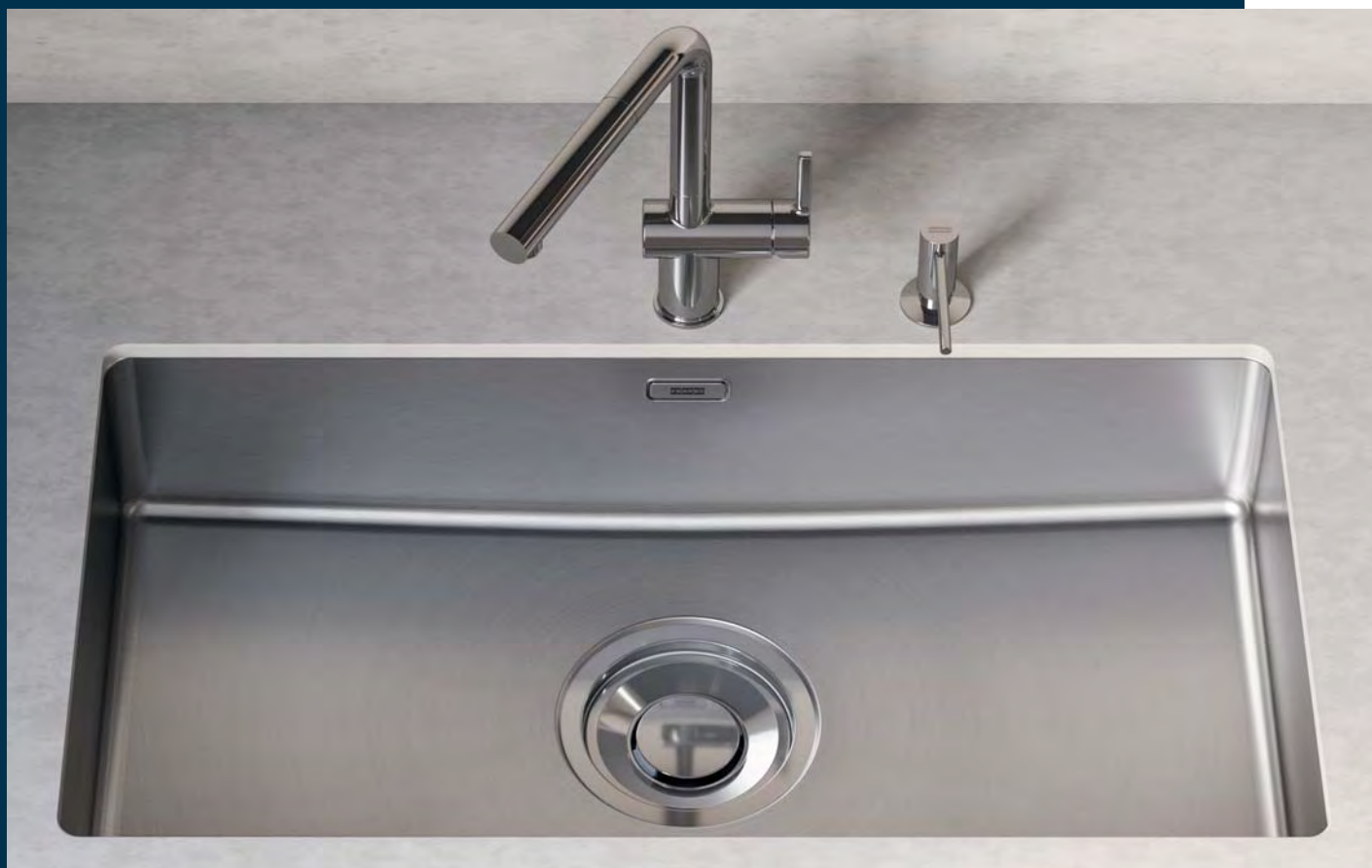

Naše novo iznimno veliko Maris Quiet korito od nehrđajućeg čelika dizajnirano je kako bi vam omogućilo doživljaj tišine i mira dok pripremate hranu na udoban i praktičan način.

Ovo veliko korito je opremljeno našim ekskluzivnim Quiet Pad sustavom, dvostrukim premazom koji smanjuje buku za 20%. A kako biste uživali u kuhanju uz maksimalan mir, higijenu i sigurnost, novi Maris Quiet opremljen je košarastim cjedilom u odvodu koje se lako čisti i koje skuplja ostatke prljavštine i sprječava začepljenja i neugodne mirise.



Misli veliko

Ekstra veliko korito, veličine 82 cm.



Tiho i lijepo

Sadrži naš nevidljivi Quiet Pad sustav za smanjenje buke do 20 dB.



Higijenski i siguran

Veliki odvod od 7" s košarastim cjedilom.



Nesmetan protok

Zaboravite na začepljenja i neugodne mirise zahvaljujući košari za sakupljanje otpada.

MARIS QUIET - MQX 110-50 - ugradnja pod radnu ploču



NOVO



1

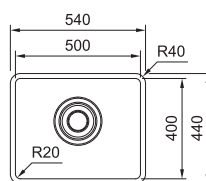

Završna obrada



Nehrđajući čelik

FUN broj

122.0694.477

Ormar

Dimenzije Š x D

Ugradni otvor Š x D

Dubina korita

Rub

600 mm

500 x 400 mm

vidi uputu

187,7 mm

slim top

MARIS QUIET - MQX 110-82 - ugradnja pod radnu ploču



NOVO



1

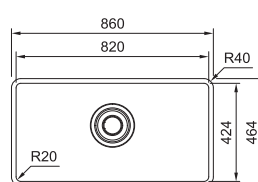

Završna obrada



Nehrđajući čelik

FUN broj

122.0694.479

Ormar

Dimenzije Š x D

Ugradni otvor Š x D

Dubina korita

Rub

900 mm

820 x 424 mm

vidi uputu

190 mm

slim top



1

ALL-IN-ONE setovi
Više na str. 105

Box Center



Poklopac odvoda

Elegantni čelični poklopac pokriva odvod sudopera Box-Center čime doprinosi estetici.

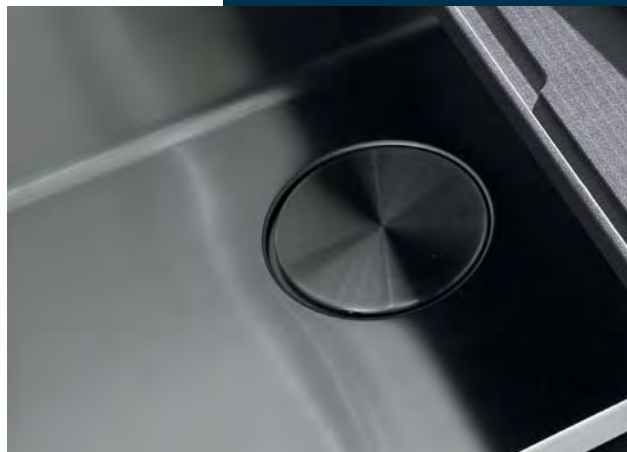

Pribor

Sudoper i pribor Box-Center međusobno se integriraju. Drvena daska za rezanje, daska za rezanje Hygenia, kadica od nehrđajućeg čelika i set od 3 noža zatvoreni su u kompaktnom i funkcionalnom rješenju.



Fast-Fix sustav

Patentirani sustav učvršćenja omogućuje vam ugradnju FRANKE sudopera brzo i jednostavno. Nakon što je silikon postavljen, jednostavno stavite sudoper na kuhinjsku ploču i lagano pritisnite prema dolje.

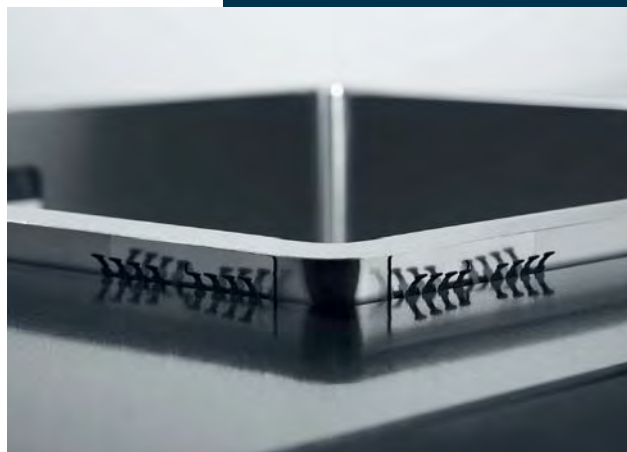

Poravnana i poluporavnana ugradnja / ugradnja pod radnu ploču

Idealan način za ugradnju FRANKE sudopera na čvrste i laminirane površine, jednostavan za ugradnju i čišćenje. Rub debljine 1 mm idealan je za poluporavnanu i poravnanu ugradnju u kuhinja-
ma čije su radne ploče izrađene od kompaktnih i čvrstih materijala (kamene, mramorne, inox i kompaktne ploče).



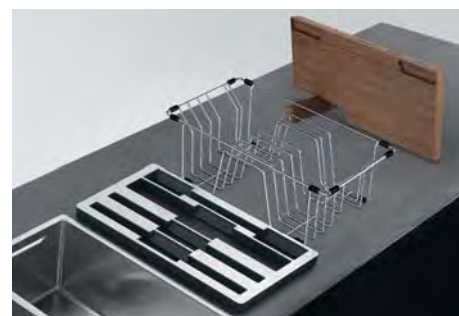

BOX CENTER - BWX 220-54-27 - poravnana i poluporavnana ugradnja

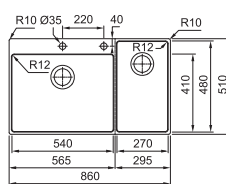
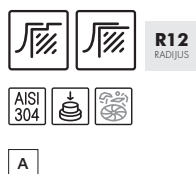

Završna obrada	FUN broj
Nehrđajući čelik	127.0538.259 127.0538.260
Ormar	900 mm
Dimenzije Š x D	860 x 510 mm
Ugradni otvor Š x D	vidi uputu
Dubina korita	200 mm /200 mm
Rub	slim top

BOX CENTER - BWX 220-41-27 - poravnana i poluporavnana ugradnja

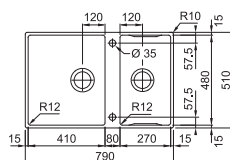

Završna obrada	FUN broj
Nehrđajući čelik	127.0579.559
Ormar	900 mm
Dimenzije Š x D	790 x 510 mm
Ugradni otvor Š x D	vidi uputu
Dubina korita	200 mm /200 mm
Rub	slim top

BOX CENTER





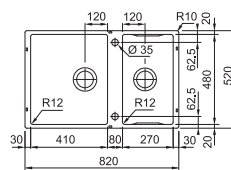
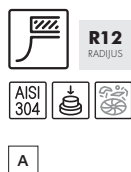

BOX CENTER - BWX 120-41-27 - ugradnja pod radnu ploču



Završna obrada

 Nehrđajući čelik

FUN broj

122.0579.553 

Ormar

Dimenzije Š x D
Ugradni otvor Š x D
Dubina korita
Rub

900 mm
820 x 520 mm
vidi uputu
200 mm /200 mm
-

BOX CENTER



Tri noža

Drvena daska

Ploča za rezanje
Hygenia

Držac tanjura

Kadica/cjedilo inox

Držac noževa

Mythos



Super tanak rub

Ekskluzivni rub od 6 mm lijepo uokviruje novi Mythos sudoper, dizajnirajući bešavnu površinu koja se lijepo stapa s radnom pločom.

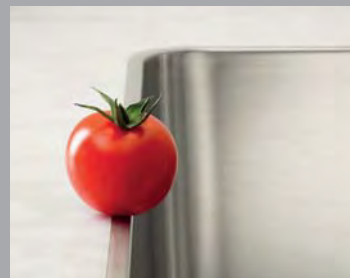

Različiti radijusi

25 mm za gornji i 10 mm za donji radijus: jedinstvene značajke koje istodobno daju ljepotu u obliku i optimalnu praktičnost za čišćenje sudopera.



Poklopac odvoda

Poklopac odvoda od četkanog čelika integrira se u sudoper Mythos, elegantno pokriva odvod kako bi se osigurala maksimalna čistoća.



Pribor

Svaki detalj osmišljen je tako da svaku vašu gestu učini jednostavnom. Kreativnost i funkcionalnost: to su tajne Mythos dodatnog pribora.



MYTHOS - MYX 210-34 - poravnana i poluporavnana ugradnja

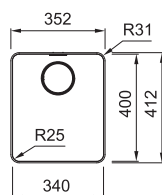
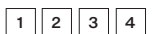

Završna obrada

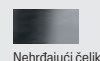

Nehrdajući čelik

FUN broj

127.0618.769

Ormar

Dimenzije Š x D

Ugradni otvor Š x D

Dubina korita

Rub

400 mm

352 x 412 mm

vidi uputu

200 mm

slim top

MYTHOS - MYX 210-45 - poravnana i poluporavnana ugradnja

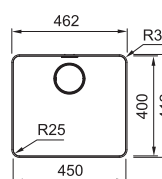
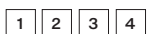

Završna obrada

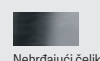

Nehrdajući čelik

FUN broj

127.0618.824

Ormar

Dimenzije Š x D

Ugradni otvor Š x D

Dubina korita

Rub

500 mm

462 x 412 mm

vidi uputu

200 mm

slim top

MYTHOS



1
112.0659.398
Kadica/cjedilo inox



2
112.0591.082
Ploča za rezanje
crna

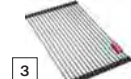

3
112.0591.081
Rollmat podloška

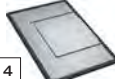

4
112.0602.288
Mobilni ocjediivač

MYTHOS - MYX 210-50 - poravnana i poluporavnana ugradnja

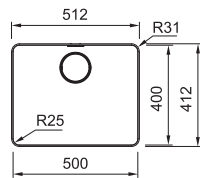
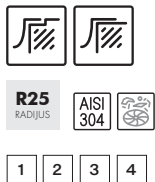

Završna obrada	FUN broj
Nehrdajući čelik	127.0618.826
Ormar	600 mm
Dimenzije Š x D	512 x 412 mm
Ugradni otvor Š x D	vidi uputu
Dubina korita	200 mm
Rub	slim top

MYTHOS - MYX 210-55 - poravnana i poluporavnana ugradnja

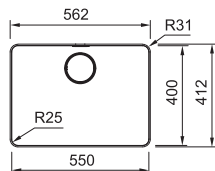
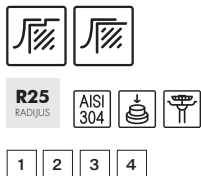

Završna obrada	FUN broj
Nehrdajući čelik	127.0625.054
Ormar	600 mm
Dimenzije Š x D	562 x 412 mm
Ugradni otvor Š x D	556 x 406 mm (R28)
Dubina korita	200 mm
Rub	slim top

MYTHOS - MYX 210-70 - poravnana i poluporavnana ugradnja

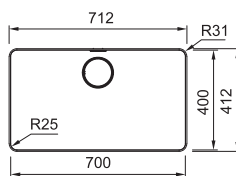
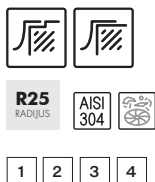

Završna obrada	FUN broj
Nehrdajući čelik	127.0618.827
Ormar	800 mm
Dimenzije Š x D	712 x 412 mm
Ugradni otvor Š x D	vidi uputu
Dubina korita	200 mm
Rub	slim top



MYTHOS



MYTHOS - MYX 110-16 - ugradnja pod radnu ploču

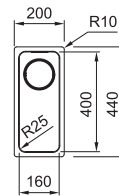
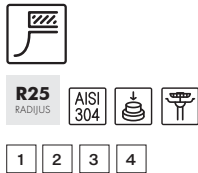

Završna obrada Nehrdajući čelik	FUN broj 122.0627.021
Ormar	300 mm
Dimenzije Š x D	200 x 440 mm
Ugradni otvor Š x D	160 x 400 (R25)
Dubina korita	150 mm
Rub	-

MYTHOS - MYX 110-34 - ugradnja pod radnu ploču

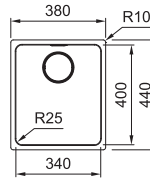
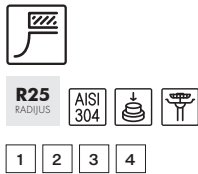

Završna obrada Nehrdajući čelik	FUN broj 122.0625.056
Ormar	450 mm
Dimenzije Š x D	380 x 440 mm
Ugradni otvor Š x D	340 x 400 (R25)
Dubina korita	200 mm
Rub	-

MYTHOS - MYX 110-45 - ugradnja pod radnu ploču

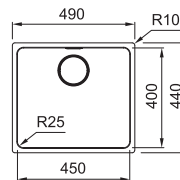
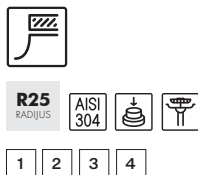

Završna obrada Nehrdajući čelik	FUN broj 122.0625.057
Ormar	550 mm
Dimenzije Š x D	490 x 440 mm
Ugradni otvor Š x D	450 x 400 (R25)
Dubina korita	200 mm
Rub	-

MYTHOS - MYX 110-50 - ugradnja pod radnu ploču

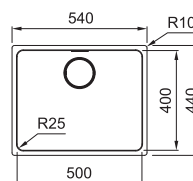
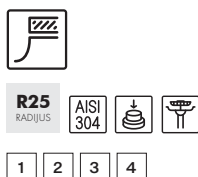

Završna obrada Nehrdajući čelik	FUN broj 122.0622.698
Ormar	600 mm
Dimenzije Š x D	540 x 440 mm
Ugradni otvor Š x D	500 x 400 (R25)
Dubina korita	200 mm
Rub	-

MYTHOS - MYX 110-55 - ugradnja pod radnu ploču



NAPOMENA: Prilikom ugradnje u osnovni ormar od 60 cm, bočne stijenke sudopera moraju se izrezati.

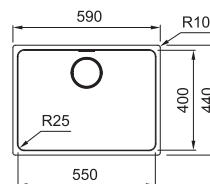

Završna obrada Nehrdajući čelik	FUN broj 122.0625.058
Ormar	600 mm
Dimenzije Š x D	590 x 440 mm
Ugradni otvor Š x D	550x400 (R25)
Dubina korita	200 mm
Rub	-

MYTHOS - MYX 110-70 - ugradnja pod radnu ploču

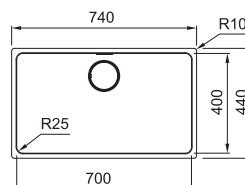
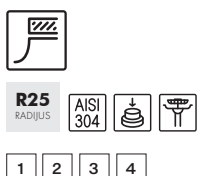

Završna obrada Nehrdajući čelik	FUN broj 122.0625.060
Ormar	800 mm
Dimenzije Š x D	740 x 440 mm
Ugradni otvor Š x D	700x400 (R25)
Dubina korita	200 mm
Rub	-

MYTHOS



- 1 112.0659.398 Kadica/cjedilo inox
- 2 112.0591.082 Ploča za rezanje crna
- 3 112.0591.081 Rollmat podloška
- 4 112.0602.288 Mobilni ocjeđivač

Box



reddot award 2015
winner

BOX - BXX 210/110-34 - univerzalna ugradnja

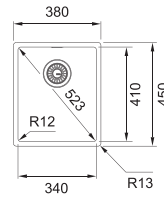
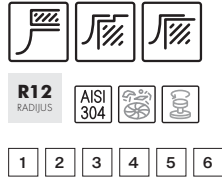

Završna obrada Nehrdajući čelik	FUN broj 127.0369.056
Ormar	400 mm
Ormar ako je podugradnja	450 mm
Dimenzije Š x D	380 x 450 mm
Ugradni otvor Š x D	vidi uputu
Dubina korita	200 mm
Rub	slim top

BOX - BXX 210/110-40 - univerzalna ugradnja

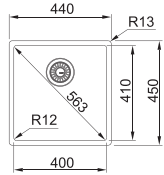
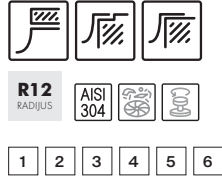

Završna obrada Nehrdajući čelik	FUN broj 127.0369.215
Ormar	450 mm
Ormar ako je podugradnja	500 mm
Dimenzije Š x D	440 x 450 mm
Ugradni otvor Š x D	vidi uputu
Dubina korita	200 mm
Rub	slim top

BOX - BXX 210/110-45 - univerzalna ugradnja

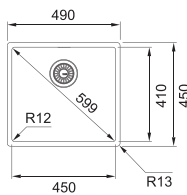
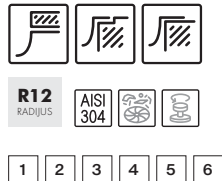

Završna obrada Nehrdajući čelik	FUN broj 127.0369.250
Ormar	500 mm
Ormar ako je podugradnja	550 mm
Dimenzije Š x D	490 x 450 mm
Ugradni otvor Š x D	vidi uputu
Dubina korita	200 mm
Rub	slim top

BOX - BXX 210/110-50 - univerzalna ugradnja

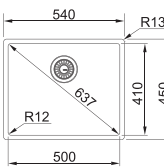
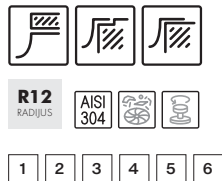

Završna obrada Nehrdajući čelik	FUN broj 127.0369.282
Ormar	550 mm
Ormar ako je podugradnja	600 mm
Dimenzije Š x D	540 x 450 mm
Ugradni otvor Š x D	vidi uputu
Dubina korita	200 mm
Rub	slim top

BOX - BXX 210/110-68 - univerzalna ugradnja

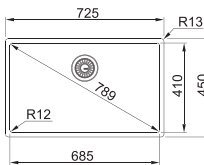

Završna obrada Nehrdajući čelik	FUN broj 127.0369.284
Ormar	800 mm
Dimenzije Š x D	725 x 450 mm
Ugradni otvor Š x D	vidi uputu
Dubina korita	200 mm
Rub	slim top

BOX - BXX 220/120 34-34 - univerzalna ugradnja

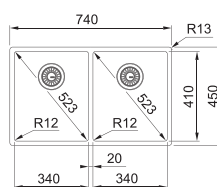

Završna obrada Nehrdajući čelik	FUN broj 127.0370.188
Ormar	800 mm
Dimenzije Š x D	740 x 450 mm
Ugradni otvor Š x D	vidi uputu
Dubina korita	200 mm
Rub	slim top

BOX



112.0394.981
Kadica/cjedilo inox

112.0539.134
Daska za rezanje

112.0557.028
Daska za rezanje

112.0539.120
Ploča za rezanje
Hygenia crna

112.0080.355
Rollmat podloška

112.0619.946
Andy Chef set daski i
noževa

BOX - BXX 210-40 TL - poravnana i poluporavnana ugradnja

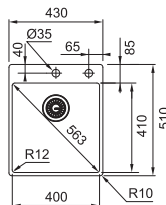
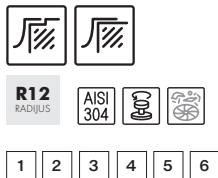

Završna obrada Nehrdajući čelik	FUN broj 127.0369.288
Ormar	450 mm
Dimenzije Š x D	430 x 510 mm
Ugradni otvor Š x D	vidi uputu
Dubina korita	200 mm
Rub	slim top

BOX - BXX 210-50 TL - poravnana i poluporavnana ugradnja

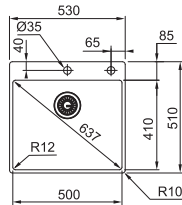
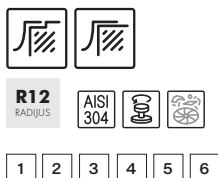

Završna obrada Nehrdajući čelik	FUN broj 127.0369.289
Ormar	550 mm
Dimenzije Š x D	530 x 510 mm
Ugradni otvor Š x D	vidi uputu
Dubina korita	200 mm
Rub	slim top

BOX - BXX 210-54 TL - poravnana i poluporavnana ugradnja

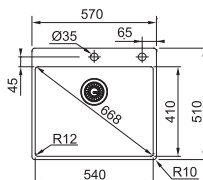
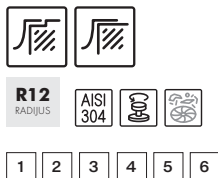

Završna obrada Nehrdajući čelik	FUN broj 127.0369.295
Ormar	600 mm
Dimenzije Š x D	570 x 510 mm
Ugradni otvor Š x D	vidi uputu
Dubina korita	200 mm
Rub	slim top

BOX - BXX 220 36-36 TL - poravnana i poluporavnana ugradnja

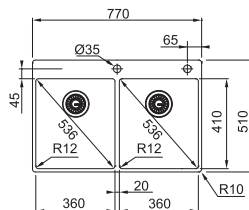
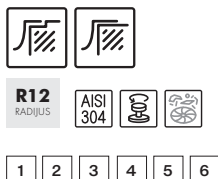

Završna obrada Nehrdajući čelik	FUN broj 127.0369.314
Ormar	800 mm / 900 mm
Dimenzije Š x D	770 x 510 mm
Ugradni otvor Š x D	vidi uputu
Dubina korita	200 mm
Rub	slim top



BOX



Planar



PLANAR - PPX 110-52 - ugradnja pod radnu ploču

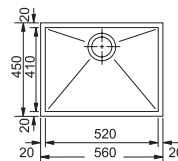
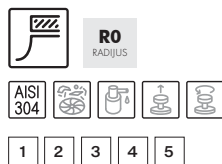

Završna obrada
Nehrdajući čelik
FUN broj
122.0203.471

Ormar
Dimenzije Š x D
Ugradni otvor Š x D
Dubina korita
Rub

600 mm
560 x 450 mm
vidi uputu
200 mm
-

PLANAR - PPX 210-58 TL - poravnana i poluporavnana ugradnja

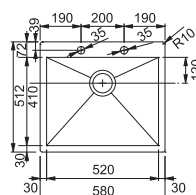
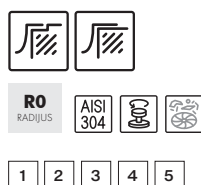

Završna obrada
Nehrdajući čelik
FUN broj
127.0203.469

Ormar
Dimenzije Š x D
Ugradni otvor Š x D
Dubina korita
Rub

600 mm
580 x 512 mm
vidi uputu
200 mm
slim top

PLANAR



1
112.0394.981
Kadica/cjedilo inox

2
112.0539.120
Ploča za rezanje
Hygenia crna

3
112.0080.355
Rollmat podloška

4
112.0539.134
Daska za rezanje

5
112.0557.028
Daska za rezanje

Maris



MARIS - MRX 210-34 - poravnana i poluporavnana ugradnja

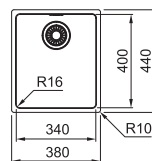
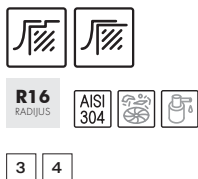

Završna obrada

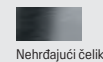

Nehrdajući čelik

FUN broj

127.0531.915

Ormar

450 mm

Dimenzije Š x D

380 x 440 mm

Ugradni otvor Š x D

vidi uputu

Dubina korita

180 mm

Rub

slim top

MARIS - MRX 210-40 - poravnana i poluporavnana ugradnja

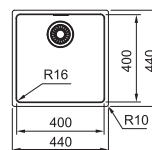
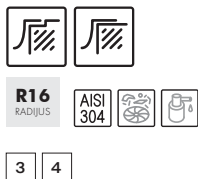

Završna obrada

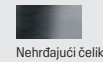

Nehrdajući čelik

FUN broj

127.0531.809

Ormar

500 mm

Dimenzije Š x D

440 x 440 mm

Ugradni otvor Š x D

vidi uputu

Dubina korita

180 mm

Rub

slim top

MARIS - MRX 210-40 TL - poravnana i poluporavnana ugradnja

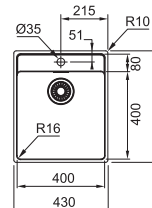
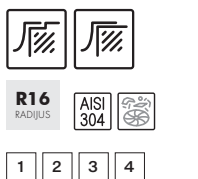

Završna obrada

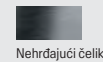

Nehrdajući čelik

FUN broj

127.0531.851

Ormar

500 mm

Dimenzije Š x D

430 x 510 mm

Ugradni otvor Š x D

vidi uputu

Dubina korita

180 mm

Rub

slim top

MARIS - poravnana i poluporavnana ugradnja



1
112.0520.471
Ploča za rezanje



2
112.0520.497
Cjedilo inox sa dodatkom



3
112.0030.882
Rollmat podloška



4
ALL-IN-ONE setovi
Više na str. 105

MARIS - MRX 210-45 - poravnana i poluporavnana ugradnja

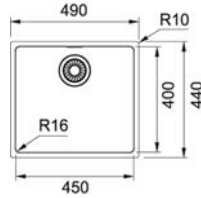
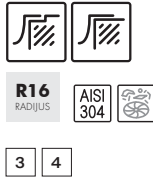

Završna obrada Nehrdajući čelik	FUN broj 127.0553.961
Ormar	500 mm
Dimenzije Š x D	490 x 440 mm
Ugradni otvor Š x D	vidi uputu
Dubina korita	180 mm
Rub	slim top

MARIS - MRX 210-50 - poravnana i poluporavnana ugradnja

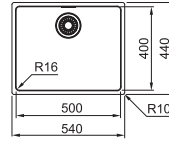
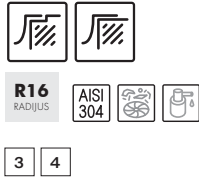

Završna obrada Nehrdajući čelik	FUN broj 127.0531.810
Ormar	600 mm
Dimenzije Š x D	540 x 440 mm
Ugradni otvor Š x D	vidi uputu
Dubina korita	180 mm
Rub	slim top

MARIS - MRX 210-50 TL - poravnana i poluporavnana ugradnja

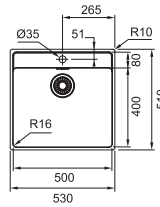
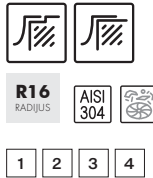

Završna obrada Nehrdajući čelik	FUN broj 127.0531.852
Ormar	600 mm
Dimenzije Š x D	530 x 510 mm
Ugradni otvor Š x D	vidi uputu
Dubina korita	180 mm
Rub	slim top

MARIS - MRX 210-70 - poravnana i poluporavnana ugradnja

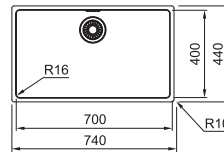
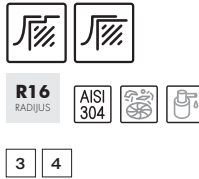

Završna obrada Nehrdajući čelik	FUN broj 127.0531.916
Ormar	800 mm
Dimenzije Š x D	740 x 440 mm
Ugradni otvor Š x D	vidi uputu
Dubina korita	180 mm
Rub	slim top

MARIS - MRX 210-70 TL - poravnana i poluporavnana ugradnja

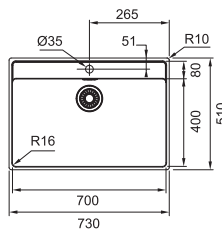

Završna obrada Nehrdajući čelik	FUN broj 127.0531.917
Ormar	800 mm
Dimenzije Š x D	730 x 510 mm
Ugradni otvor Š x D	vidi uputu
Dubina korita	180 mm
Rub	slim top

MARIS - MRX 110-34 - ugradnja pod radnu ploču

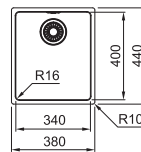
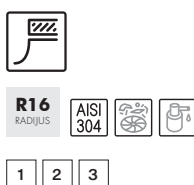

Završna obrada Nehrdajući čelik	FUN broj 122.0531.850
Ormar	450 mm
Dimenzije Š x D	380 x 440 mm
Ugradni otvor Š x D	vidi uputu
Dubina korita	180 mm
Rub	-

MARIS - poravnana i poluporavnana ugradnja

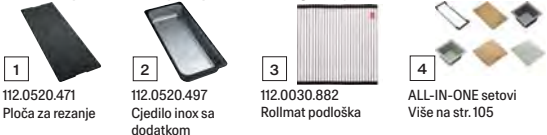

MARIS - ugradnja pod radnu ploču



MARIS - MRX 110-40 - ugradnja pod radnu ploču

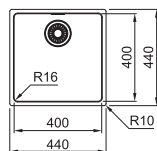
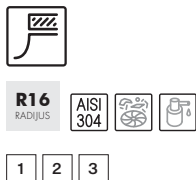

Završna obrada Nehrdajući čelik	FUN broj 122.0531.643
Ormar	450 mm
Dimenzije Š x D	440 x 440 mm
Ugradni otvor Š x D	vidi uputu
Dubina korita	180 mm
Rub	-

MARIS - MRX 110-45 - ugradnja pod radnu ploču

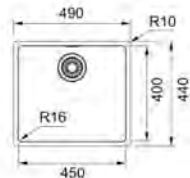
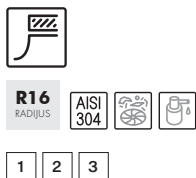

Završna obrada Nehrdajući čelik	FUN broj 122.0553.943
Ormar	550 mm
Dimenzije Š x D	490 x 440 mm
Ugradni otvor Š x D	vidi uputu
Dubina korita	180 mm
Rub	-

MARIS - MRX 110-50 - ugradnja pod radnu ploču

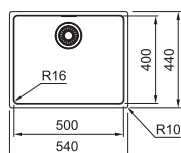
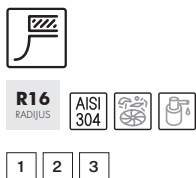

Završna obrada Nehrdajući čelik	FUN broj 122.0531.808
Ormar	550 mm
Dimenzije Š x D	540 x 440 mm
Ugradni otvor Š x D	vidi uputu
Dubina korita	180 mm
Rub	-

MARIS - MRX 110-55 - ugradnja pod radnu ploču

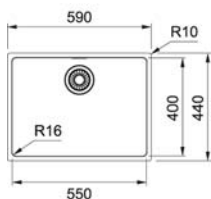
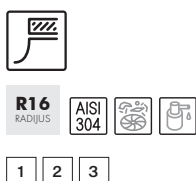

Završna obrada Nehrdajući čelik	FUN broj 122.0553.947
Ormar	800 mm
Dimenzije Š x D	590 x 440 mm
Ugradni otvor Š x D	vidi uputu
Dubina korita	180 mm
Rub	-

MARIS - MRX 110-70 - ugradnja pod radnu ploču

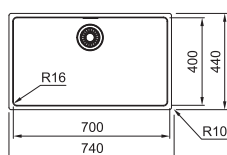
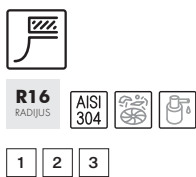

Završna obrada Nehrdajući čelik	FUN broj 122.0531.911
Ormar	800 mm
Dimenzije Š x D	740 x 440 mm
Ugradni otvor Š x D	vidi uputu
Dubina korita	180 mm
Rub	-

MARIS - MRX 160-34-19 - ugradnja pod radnu ploču

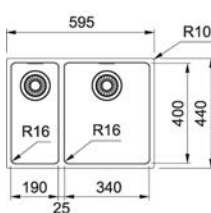
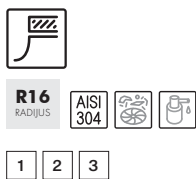

Završna obrada Nehrdajući čelik	FUN broj 122.0594.258*** ***po narudžbi
Ormar	800 mm
Dimenzije Š x D	595 x 440 mm
Ugradni otvor Š x D	vidi uputu
Dubina korita	130 / 180 mm
Rub	-

MARIS - ugradnja pod radnu ploču

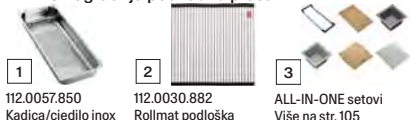



ATON - ANX 110-34 - ugradnja pod radnu ploču



R36
RADIJUS

AISI 304

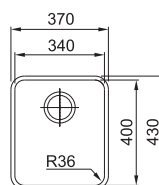
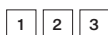

Završna obrada



Nehrdajući čelik

FUN broj

122.0204.647

Ormar

450 mm

Dimenzije Š x D

370 x 430 mm

Ugradni otvor Š x D

vidi uputu

Dubina korita

190 mm

Rub

-

ATON - ANX 110-48 - ugradnja pod radnu ploču



R36
RADIJUS

AISI 304

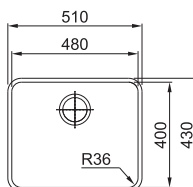
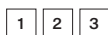

Završna obrada



Nehrdajući čelik

FUN broj

122.0204.649

Ormar

600 mm

Dimenzije Š x D

510 x 430 mm

Ugradni otvor Š x D

vidi uputu

Dubina korita

190 mm

Rub

-

ATON - ANX 120 - ugradnja pod radnu ploču



R36
RADIJUS

AISI 304

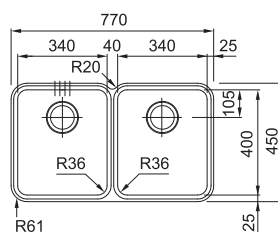
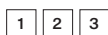

Završna obrada



Nehrdajući čelik

FUN broj

122.0536.341

Ormar

900 mm

Dimenzije Š x D

770 x 450 mm

Ugradni otvor Š x D

vidi uputu

Dubina korita

190 mm

Rub

-

ATON



1
112.0030.882
Rollmat podloška



2
112.0057.850
Kadica/cjedilo inox



3
ALL-IN-ONE setovi
Više na str. 105

Sottotop



SOTTOTOP - AMX 160 - ugradnja pod radnu ploču

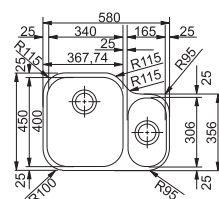
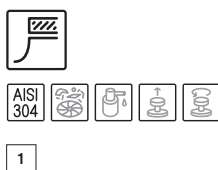

Završna obrada



Nehrdajući čelik

FUN broj

122.0021.448

Ormar

800 mm

Dimenzije Š x D

580 x 450 mm

Ugradni otvor Š x D

vidi uputu

Dubina korita

190 mm/130 mm

Rub

-

SOTTOTOP - AMX 120 - ugradnja pod radnu ploču

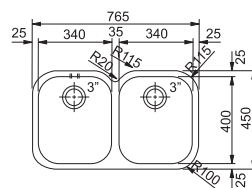
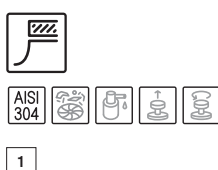

Završna obrada



Nehrdajući čelik

FUN broj

122.0021.446

Ormar

900 mm

Dimenzije Š x D

765 x 450 mm

Ugradni otvor Š x D

vidi uputu

Dubina korita

190 mm

Rub

-

SOTTOTOP



1

ALL-IN-ONE setovi
Više na str. 105

SOTTOTOP - GAX 110-30 - ugradnja pod radnu ploču



1

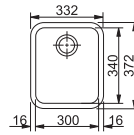

Završna obrada

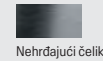

Nehrdajući čelik

FUN broj

122.0021.439

Ormar

400 mm

Dimenzije Š x D

332 x 372 mm

Ugradni otvor Š x D

vidi uputu

Dubina korita

170 mm

Rub

-

SOTTOTOP - SVX 110-40 - ugradnja pod radnu ploču



1

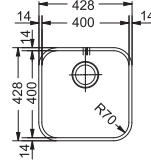

Završna obrada

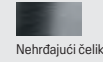

Nehrdajući čelik

FUN broj

122.0039.092

Ormar

600 mm

Dimenzije Š x D

428 x 428 mm

Ugradni otvor Š x D

vidi uputu

Dubina korita

190 mm

Rub

-

SOTTOTOP - GAX 110-45 - ugradnja pod radnu ploču



1

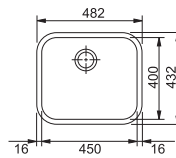

Završna obrada

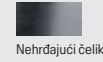

Nehrdajući čelik

FUN broj

122.0021.440

Ormar

600 mm

Dimenzije Š x D

482 x 432 mm

Ugradni otvor Š x D

vidi uputu

Dubina korita

190 mm

Rub

-

SOTTOTOP



1

ALL-IN-ONE setovi
Više na str. 105

Smart



SMART - SRX 210-40 TL - poravnana i poluporavnana ugradnja



1

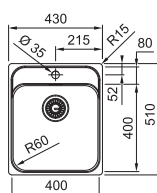

Završna obrada

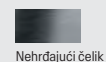

Nehrdajući čelik

FUN broj

127.0704.666

Ormar

500 mm

Dimenzije Š x D

430 x 510 mm

Ugradni otvor Š x D

vidi uputu

Dubina korita

171 mm

Rub

-

SMART - SRX 210-50 TL - poravnana i poluporavnana ugradnja



1

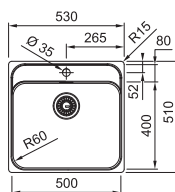

Završna obrada

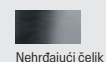

Nehrdajući čelik

FUN broj

127.0704.667

Ormar

600 mm

Dimenzije Š x D

530 x 510 mm

Ugradni otvor Š x D

vidi uputu

Dubina korita

171 mm

Rub

-

SMART



1

ALL-IN-ONE setovi
Više na str. 105



BELL - BCX 610-51 - standardna ugradnja



AISI 304

1

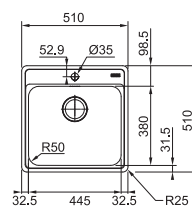

Završna obrada

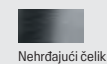

Nehrdajući čelik

FUN broj

101.0622.893

Ormar

600 mm

Dimenzije Š x D

510 x 510 mm

Ugradni otvor Š x D

486 x 486 mm (R10-20)

Dubina korita

200 mm

Rub

standard

BELL - BCX 610-81 - standardna ugradnja



AISI 304

1

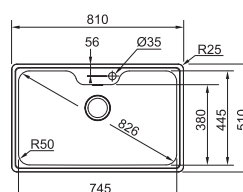

Završna obrada

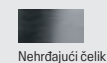

Nehrdajući čelik

FUN broj

101.0693.352

Ormar

900 mm

Dimenzije Š x D

810 x 510 mm

Ugradni otvor Š x D

788 x 488 mm (R10-20)

Dubina korita

200 mm

Rub

standard



ALL-IN-ONE setovi
Više na str.105

Spark



SPARK - SKN 610-37 - standardna ugradnja



NOVO



1

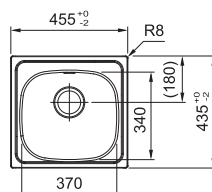

Sudoperi se isporučuju bez kartonske kutije u kompletu s odvodnim elementima i sifonom.

Završna obrada



Nehrdajući čelik

FUN broj

101.0708.052

Ormar

450 mm

Dimenzije Š x D

455 x 435 mm

Ugradni otvor Š x D

435 x 415 mm

Dubina korita

150 mm

Rub

standard

SPARK



1

ALL-IN-ONE setovi
Više na str. 105

Rotondo



Fotografija je simbolična.
Ovaj model sudopera nije u ponudi.

ROTONDO - ROX 610-39 - standardna ugradnja



NOVO



Sudoperi RON 610-39 se isporučuju u kompletu s odvodnim elementima bez sifona i bez kartonske kutije.

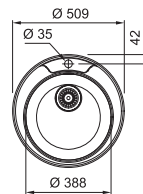

Završna obrada

Nehrđajući
čelik

FUN broj

101.0714.034

Ormar
Dimenzije Ø
Ugradni otvor Ø
Dubina korita
Rub

450 mm
510 mm
490 mm
170 mm
slim

Sudoperi od nehrđ



đajućeg



čelika

Sudoperi od nehrđajućeg čelika

Poravnana / poluporavnana ugradnja



Argos
AGX 211-62
625 x 510 mm
str. 50



Argos
AGX 211-78
780 x 510 mm
str. 50

Standardna ugradnja



Neptune Plus
NPX 611
860 x 510 mm
str. 51



Neptune Plus
NPX 620
860 x 510 mm
str. 51



Neptune
NEX 611
860 x 510 mm
str. 52



Neptune
NEX 651
1000 x 510 mm
str. 52



Neptune
NEX 620
860 x 510 mm
str. 52



Neptune
NEX 621
1160 x 510 mm
str. 52



Smart
SRX 611-86
860 x 500 mm
str. 53



Smart
SRX 611-86 LB
860 x 500 mm
str. 53



Smart
SRX 651
1000 x 500 mm
str. 53



Smart
SRX 620-86
860 x 500 mm
str. 53



Smart
SRX 621
1160 x 500 mm
str. 53



Logica Line
LLX 611
790 x 500 mm
str. 54



Logica Line
LLX 611-L
860 x 500 mm
str. 54



Logica Line
LLX 651
1000 x 500 mm
str. 54



Logica Line
LLX 621
1160 x 500 mm
str. 54



Spark
SKN 611-62
620 x 435 mm
str. 55



Spark
SKX 611-78
780 x 500 mm
str. 55



Spark
SKX 611-79
790 x 500 mm
str. 56



Spark
SKX 651
1000 x 500 mm
str. 56



Spark
SKX 620-80
800 x 500 mm
str. 56



Flash
FLN 611-78
780 x 435 mm
str. 57

Argos



ARGOS - AGX 211-62 - poravnana i poluporavnana ugradnja



1 2

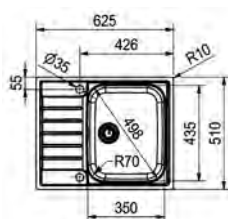

Završna obrada

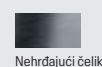

Nehrdajući čelik

FUN broj

127.0476.450



Ormar

Dimenzije Š x D

Ugradni otvor Š x D

Dubina korita

Rub

450 mm/ 600 mm

625 x 510 mm

612 x 497 mm (R10)

175 mm

slim top

ARGOS - AGX 211-78 - poravnana i poluporavnana ugradnja



1 2

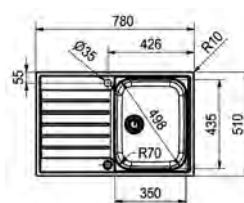

Završna obrada

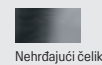

Nehrdajući čelik

FUN broj

127.0476.541



Ormar

Dimenzije Š x D

Ugradni otvor Š x D

Dubina korita

Rub

450 mm

780 x 510 mm

767 x 497 mm (R10)

175 mm

slim top

ARGOS

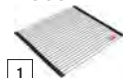

1
112.0281.982
Daska za rezanje



2
ALL-IN-ONE setovi
Više na str.105

Neptune Plus



Fotografija je simbolična.
Ovaj model sudopera nije u ponudi.

NEPTUNE PLUS - NPX 611 - standardna ugradnja

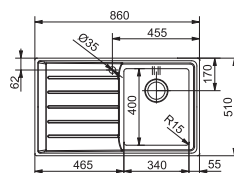

Završna obrada

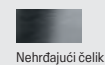

FUN broj

101.0068.368
101.0068.360



Ormar

Dimenzije Š x D

Ugradni otvor Š x D

Dubina korita

Rub

600 mm

860 x 510 mm

840 x 490 mm

200 mm

slim

NEPTUNE PLUS - NPX 620 - standardna ugradnja

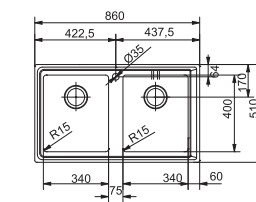

Završna obrada

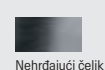

FUN broj

101.0068.373

Ormar

Dimenzije Š x D

Ugradni otvor Š x D

Dubina korita

Rub

800 mm (900 završni)

860 x 510 mm

840 x 490 mm

200 mm

slim

NEPTUNE PLUS



1
112.0057.850
Kadica/cjedilo inox

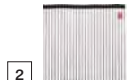

2
112.0030.882
Rollmat podloška



3
ALL-IN-ONE setovi
Više na str. 105

Neptune



NEPTUNE - NEX 611 - standardna ugradnja

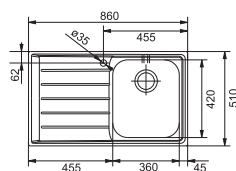
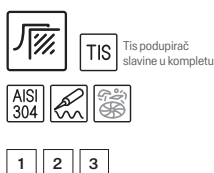

Završna obrada

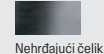

Nehrđajući čelik

FUN broj

101.0040.731

101.0040.732



Ormar

Dimenzije Š x D

Ugradni otvor Š x D

Dubina korita

Rub

600 mm

860 x 510 mm

840 x 490 mm

200 mm

slim

NEPTUNE - NEX 651 - standardna ugradnja

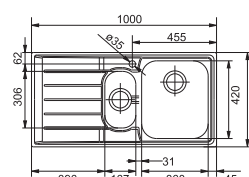
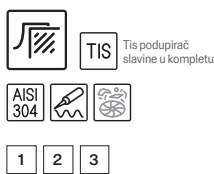

Završna obrada

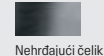

Nehrđajući čelik

FUN broj

101.0040.737

101.0040.738



Ormar

Dimenzije Š x D

Ugradni otvor Š x D

Dubina korita

Rub

600 mm (800 završni)

1000 x 510 mm

980 x 490 mm

200 mm / 165 mm

slim

NEPTUNE - NEX 620 - standardna ugradnja

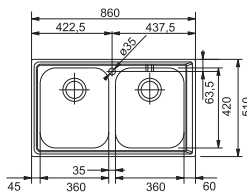
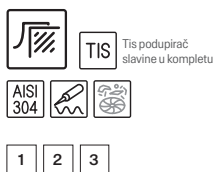

Završna obrada

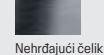

Nehrđajući čelik

FUN broj

101.0040.733

Ormar

Dimenzije Š x D

Ugradni otvor Š x D

Dubina korita

Rub

800 mm (900 završni)

860 x 510 mm

840 x 490 mm

200 mm

slim

NEPTUNE - NEX 621 - standardna ugradnja

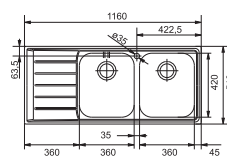

Završna obrada

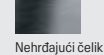

Nehrđajući čelik

FUN broj

101.0040.734

101.0040.736



Ormar

Dimenzije Š x D

Ugradni otvor Š x D

Dubina korita

Rub

800 mm (900 završni)

1160 x 510 mm

1140 x 490 mm

200 mm

slim

NEPTUNE



SMART - SRX 611-86 - standardna ugradnja

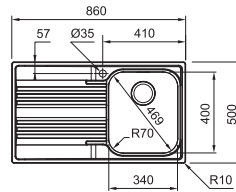

Završna obrada

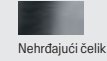

Nehrdajući čelik

FUN broj

101.0356.758



101.0356.759



Ormar

Dimenzije Š x D

Ugradni otvor Š x D

Dubina korita

Rub

450 mm (600 završni)

860 x 500 mm

840 x 480 mm

200 mm

slim

SMART - SRX 611-86 LB - standardna ugradnja

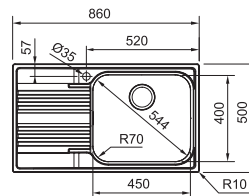

Završna obrada

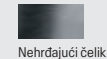

Nehrdajući čelik

FUN broj

101.0356.849



101.0356.850



Ormar

Dimenzije Š x D

Ugradni otvor Š x D

Dubina korita

Rub

600 mm

860 x 500 mm

840 x 480 mm

200 mm

slim

SMART - SRX 651 - standardna ugradnja

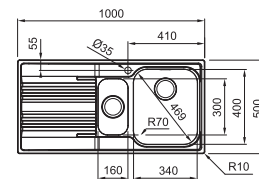

Završna obrada

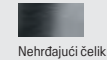

Nehrdajući čelik

FUN broj

101.0356.885



101.0356.886



Ormar

Dimenzije Š x D

Ugradni otvor Š x D

Dubina korita

Rub

600 mm (800 završni)

1000 x 500 mm

980 x 480 mm

200 mm/140 mm

slim

SMART - SRX 620-86 - standardna ugradnja

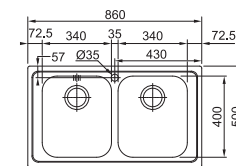

Završna obrada

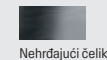

Nehrdajući čelik

FUN broj

101.0356.664

Ormar

Dimenzije Š x D

Ugradni otvor Š x D

Dubina korita

Rub

800 mm (900 završni)

860 x 500 mm

840 x 480 mm

200 mm

slim

SMART - SRX 621 - standardna ugradnja

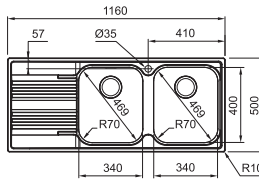

Završna obrada

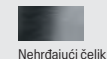

Nehrdajući čelik

FUN broj

101.0356.893



101.0356.894



Ormar

Dimenzije Š x D

Ugradni otvor Š x D

Dubina korita

Rub

800 mm

1160 x 500 mm

1140 x 480 mm

200 mm

slim

SMART



112.0049.608
Rešetka inox

112.0057.850
Kadica/cjedilo inox

112.0041.519
Kadica/cjedilo inox

ALL-IN-ONE setovi
Više na str. 105

Logica Line



LOGICA LINE - LLX 611 - standardna ugradnja

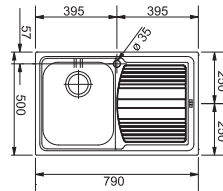

Završna obrada

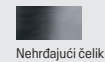

FUN broj

101.0152.578
101.0152.582



Ormar

Dimenzije Š x D
Ugradni otvor Š x D
Dubina korita
Rub

450 mm
790 x 500 mm
770 x 480 mm
195 mm
slim

LOGICA LINE - LLX 611-L - standardna ugradnja

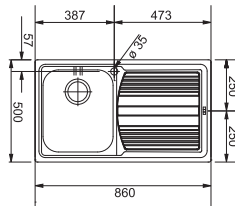

Završna obrada

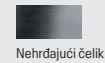

FUN broj

101.0152.583
101.0152.585



Ormar

Dimenzije Š x D
Ugradni otvor Š x D
Dubina korita
Rub

450 mm
860 x 500 mm
840 x 480 mm
195 mm
slim

LOGICA LINE - LLX 651 - standardna ugradnja

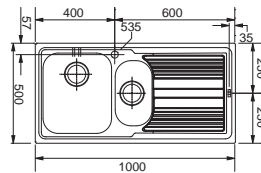

Završna obrada

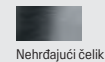

FUN broj

101.0150.830
101.0150.832



Ormar

Dimenzije Š x D
Ugradni otvor Š x D
Dubina korita
Rub

600 mm (800 završni)
1000 x 500 mm
980 x 480 mm
195 mm / 165 mm
slim

LOGICA LINE - LLX 621 - standardna ugradnja

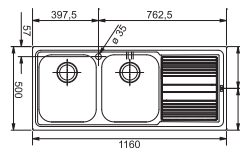

Završna obrada

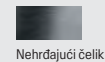

FUN broj

101.0150.851
101.0152.588



Ormar

Dimenzije Š x D
Ugradni otvor Š x D
Dubina korita
Rub

800 mm
1160 x 500 mm
1140 x 480 mm
195 mm
slim

LOGICA LINE



Spark



SPARK - SKN 611-62 - standardna ugradnja



NOVO

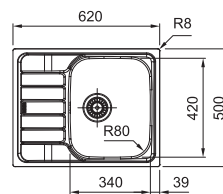

Završna obrada

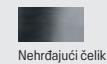

Nehrdajući čelik

FUN broj

101.0717.455



Ormar

450 mm

Dimenzije Š x D

620 x 435 mm

Ugradni otvor Š x D

600 x 415 mm

Dubina korita

150 mm

Rub

standard

SPARK - SKX 611-78 - standardna ugradnja



NOVO

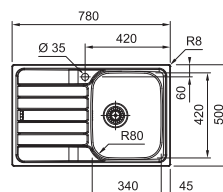

Završna obrada

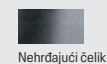

Nehrdajući čelik

FUN broj

101.0712.130



101.0712.129



Ormar

450 mm

Dimenzije Š x D

780 x 500 mm

Ugradni otvor Š x D

760 x 480 mm

Dubina korita

160 mm

Rub

standard

SPARK



1
112.0595.334
Daska za rezanje



2
ALL-IN-ONE setovi
Više na str. 105

SPARK - SKX 611-79 - standardna ugradnja

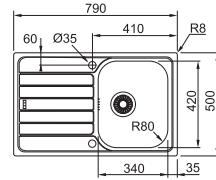

Završna obrada Nehrdajući čelik	FUN broj 101.0554.878
Ormar	450 mm
Dimenzije Š x D	790 x 500 mm
Ugradni otvor Š x D	770 x 480 mm
Dubina korita	160 mm
Rub	slim

SPARK - SKX 651 - standardna ugradnja

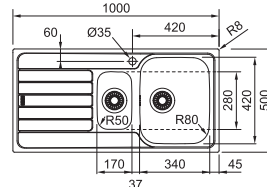

Završna obrada Nehrdajući čelik	FUN broj 101.0716.614 101.0716.615
Ormar	600 mm (800 završni)
Dimenzije Š x D	1000 x 500 mm
Ugradni otvor Š x D	980 x 480 mm
Dubina korita	155 mm / 80 mm
Rub	standard

SPARK - SKX 620-80 - standardna ugradnja

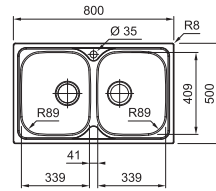
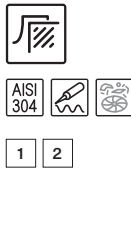

Završna obrada Nehrdajući čelik	FUN broj 101.0712.131
Ormar	800 mm (900 završni)
Dimenzije Š x D	800 x 500 mm
Ugradni otvor Š x D	780 x 480 mm
Dubina korita	150 mm
Rub	standard



SPARK



112.0595.334
Daska za rezanje

ALL-IN-ONE setovi
Više na str. 105

Flash



Fotografija je simbolična.
Ovaj model sudopera nije u ponudi.

FLASH - FLN 611-78 - standardna ugradnja



NOVO



AISI
304

1

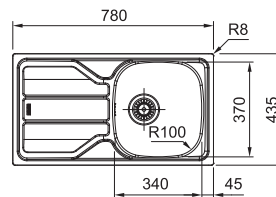

Sudoperi se isporučuju bez kartonske kutije u kompletu s odvodnim elementima i sifonom.

Završna obrada

Nepolirani
nehrđajući čelik

Ormar

Dimenzije Š x D

Ugradni otvor Š x D

Dubina korita

Rub

FUN broj

101.0708.161



450 mm

780 x 435 mm

760 x 415 mm

150 mm

standard

FLASH



1

ALL-IN-ONE setovi
Više na str. 105

Korita od



FRAGRANITA



Korita od fragranita

Standardna ugradnja



Maris 2.0
MRG 610-37 TLA
410 x 510 mm
str. 64



Maris 2.0
MRG 610-52 TLA
560 x 510 mm
str. 64



Maris 2.0
MRG 610-72 TLA
760 x 510 mm
str. 64



Maris 2.0
MRG 610-52
560 x 440 mm
str. 66



Maris 2.0
MRG 610-52 TL
560 x 510 mm
str. 66



Maris 2.0
MRG 610-72
760 x 440 mm
str. 66



Maris 2.0
MRG 610-72 TL
760 x 510 mm
str. 66



Maris 2.0
MRG 620-35-35
760 x 440 mm
str. 67



Maris 2.0
MRG 620-35-35 TL
760 x 510 mm
str. 67



Maris 2.0
MRG 610-37 TLA
410 x 510 mm
str. 69



Maris 2.0
MRG 610-52 TLA
560 x 510 mm
str. 69



Maris 2.0
MRG 610-72 TLA
760 x 510 mm
str. 69



Maris 2.0
MRG 610-52
560 x 440 mm
str. 70



Maris 2.0
MRG 610-52 TL
560 x 510 mm
str. 70



Maris
MRG 610-54 FTL
590 x 500 mm
str. 72



Maris
MRG 610-73 FTL
780 x 500 mm
str. 72



Maris
MRG 620-39-39 FTL
860 x 500 mm
str. 72



Urban 2.0
UBG 610-50 A
560 x 500 mm
str. 74



Urban 2.0
UBG 610-50
560 x 500 mm
str. 74



Urban 2.0
UBG 610-72
780 x 500 mm
str. 74



Urban 2.0
UBG 620-78
780 x 500 mm
str. 75



Urban 2.0
UBG 620-86
860 x 500 mm
str. 75



Pamira
ROG 610-41
Ø 510 mm
str. 75

Poravnana ugradnja



Maris 2.0
MRG 210-52 A
553 x 433 mm
str. 65



Maris 2.0
MRG 210-52 TLA
553 x 503 mm
str. 65

Ugradnja pod radnu ploču



Maris 2.0
MRG 110-37 A
403 x 433 mm
str. 65



Maris 2.0
MRG 110-37 TL
403 x 503 mm
str. 65



Maris 2.0
MRG 110-52 A
553 x 433 mm
str. 65



Maris 2.0
MRG 110-52 TLA
553 x 503 mm
str. 65



Maris 2.0
MRG 110-72 A
753 x 433 mm
str. 66



Maris 2.0
MRG 110-72 TLA
753 x 503 mm
str. 66



Maris 2.0
MRG 110-37
403 x 433 mm
str. 67



Maris 2.0
MRG 110-52
553 x 433 mm
str. 67



Maris 2.0
MRG 110-62
653 x 433 mm
str. 67



Maris 2.0
MRG 110-72
753 x 433 mm
str. 67



Maris 2.0
MRG 120-35-35
753 x 433 mm
str. 68



Kubus 2
KNG 120
760 x 460 mm
str. 68



Maris 2.0
MRG 110-52 A
553 x 433 mm
str. 70



Maris 2.0
MRG 110-37
403 x 433 mm
str. 70



Maris 2.0
MRG 110-52
553 x 433 mm
str. 70



Maris 2.0
MRG 110-62
653 x 433 mm
str. 70



Maris 2.0
MRG 110-72
753 x 433 mm
str. 71



Kubus 2
KNG 110-37
410 x 460 mm
str. 73



Kubus 2
KNG 110-52
560 x 460 mm
str. 73



Kubus 2
KNG 110-62
760 x 460 mm
str. 73



Kubus 2
KNG 120
760 x 460 mm
str. 73

Black collection



Total Black Matt elegantan i zavodljiv

Kompletan asortiman korita i sudopera odjevenih u apsolutno crno



Bezvremenska i zavodljiva. Crna mat je tajnovita i elegantna. Nova boja kolekcije Fraganit izuzetno je profinjena i odlučna. Duboka crna, poboljšana matiranom formulom i glatkom neporoznom površinom.

Apsolutno i neočekivano. Black Matt, crna mat boja koja priziva čistoću i daje elegantan dizajn bilo kojem okruženju. Živopisnog tonaliteta apsolutno sposobna poboljšati profinjeni Franke dizajn.

Svi elementi kolekcije Total Black Matt savršeno se slažu s koritima i sudoperima. Birajte između brojnih modela dostupnih u verzijama s ili bez integrirane police za slavinu te u opcijama standardne, poravnane ili ugradnje pod radnu ploču.

Sve od odvoda do preljeva je iste boje. Nadalje, zahvaljujući posebnom UV aditivu uključenom u proizvodni proces, neće promijeniti boju tijekom vremena.



Maris 2.0

Black collection



MARIS 2.0 - MRG 610-37 TLA - standardna ugradnja



1 2 3

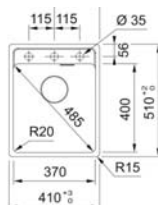

Završna obrada / FUN broj

114.0659.123
Crna mat

Ormar	450 mm
Dimenzije Š x D	410 x 510 mm
Ugradni otvor Š x D	390 x 500
Dubina korita	200 mm
Rub	standard

MARIS 2.0 - MRG 610-52 TLA - standardna ugradnja



1 2 3

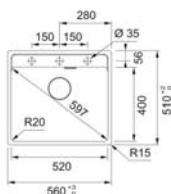

Završna obrada / FUN broj

114.0659.124
Crna mat

Ormar	600 mm
Dimenzije Š x D	560 x 510 mm
Ugradni otvor Š x D	540 x 500
Dubina korita	200 mm
Rub	standard

MARIS 2.0 - MRG 610-72 TLA - standardna ugradnja



1 2 3

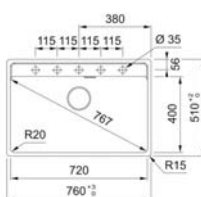

Završna obrada / FUN broj

114.0659.125
Crna mat

Ormar	600 mm
Dimenzije Š x D	760 x 510 mm
Ugradni otvor Š x D	740 x 500
Dubina korita	200 mm
Rub	standard

MARIS 2.0



112.0030.882
Rollmat podložak



112.0188.651
Mobilni ocjeđivač

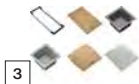

ALL-IN-ONE setovi
Više na str. 105

MARIS 2.0 - MRG 210-52 A - poravnana ugradnja



1 2 3

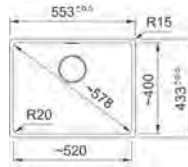

Završna obrada / FUN broj

135.0683.051
Crna mat

Ormar	600 mm
Dimenzije Š x D	553 x 433 mm
Ugradni otvor Š x D	vidi uputu
Dubina korita	200 mm
Rub	slim

MARIS 2.0 - MRG 210-52 TLA - poravnana ugradnja



1 2 3

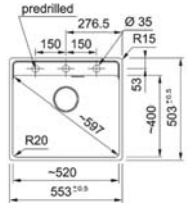

Završna obrada / FUN broj

135.0683.054
Crna mat

Ormar	600 mm
Dimenzije Š x D	553 x 503 mm
Ugradni otvor Š x D	vidi uputu
Dubina korita	200 mm
Rub	slim

MARIS 2.0 - MRG 110-37 A - ugradnja pod radnu ploču



1 2 3

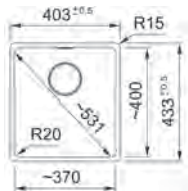

Završna obrada / FUN broj

125.0683.232
Crna mat

Ormar	450 mm
Dimenzije Š x D	403 x 433 mm
Ugradni otvor Š x D	vidi uputu
Dubina korita	200 mm
Rub	slim

MARIS 2.0 - MRG 110-37 TLA - ugradnja pod radnu ploču



1 2 3



Završna obrada / FUN broj

125.0683.238
Crna mat

Ormar	450 mm
Dimenzije Š x D	403 x 503 mm
Ugradni otvor Š x D	vidi uputu
Dubina korita	200 mm
Rub	slim

MARIS 2.0 - MRG 110-52 A - ugradnja pod radnu ploču



1 2 3

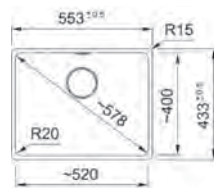

Završna obrada / FUN broj

125.0683.234
Crna mat

Ormar	600 mm
Dimenzije Š x D	553 x 433 mm
Ugradni otvor Š x D	vidi uputu
Dubina korita	200 mm
Rub	slim

MARIS 2.0 - MRG 110-52 TLA - ugradnja pod radnu ploču



1 2 3

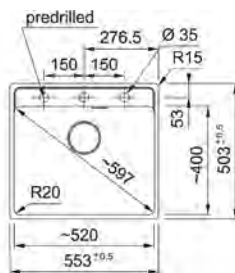

Završna obrada / FUN broj

125.0683.240
Crna mat

Ormar	600 mm
Dimenzije Š x D	553 x 503 mm
Ugradni otvor Š x D	vidi uputu
Dubina korita	200 mm
Rub	slim

MARIS 2.0



1
112.0030.882
Rollmat podložak



2
112.0188.651
Mobilni ocjeđivač

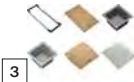

3
ALL-IN-ONE setovi
Više na str. 105

MARIS 2.0 - MRG 110-72 A - ugradnja pod radnu ploču



1 2 3

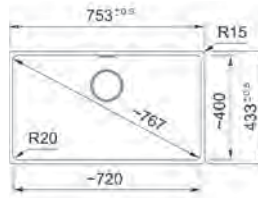

Završna obrada / FUN broj

125.0683.236
Crna mat

Ormar	800 mm
Dimenzije Š x D	753 x 433 mm
Ugradni otvor Š x D	vidi uputu
Dubina korita	200 mm
Rub	slim

MARIS 2.0 - MRG 110-72 TLA - ugradnja pod radnu ploču



1 2 3

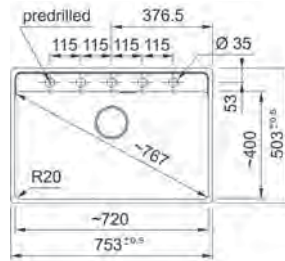

Završna obrada / FUN broj

125.0683.242
Crna mat

Ormar	800 mm
Dimenzije Š x D	753 x 503 mm
Ugradni otvor Š x D	vidi uputu
Dubina korita	200 mm
Rub	slim

MARIS 2.0 - MRG 610-52 - standardna ugradnja



1 2 3

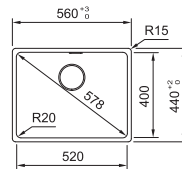

Završna obrada / FUN broj

114.0661.658
Crna mat

Ormar	600 mm
Dimenzije Š x D	560 x 440 mm
Ugradni otvor Š x D	540 x 428 (R15)
Dubina korita	200 mm
Rub	standard

MARIS 2.0 - MRG 610-52 TL - standardna ugradnja



1 2 3

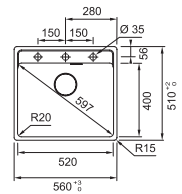

Završna obrada / FUN broj

114.0661.642
Crna mat

Ormar	600 mm
Dimenzije Š x D	560 x 510 mm
Ugradni otvor Š x D	540 x 498 (R15)
Dubina korita	200 mm
Rub	standard

MARIS 2.0 - MRG 610-72 - standardna ugradnja



1 2 3

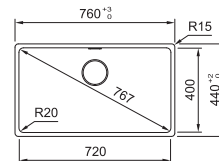

Završna obrada / FUN broj

114.0661.650
Crna mat

Ormar	800 mm
Dimenzije Š x D	760 x 440 mm
Ugradni otvor Š x D	740 x 428 (R15)
Dubina korita	200 mm
Rub	standard

MARIS 2.0 - MRG 610-72 TL - standardna ugradnja



1 2 3

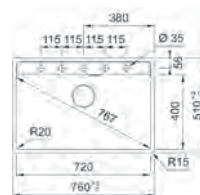

Završna obrada / FUN broj

114.0661.666
Crna mat

Ormar	800 mm
Dimenzije Š x D	760 x 510 mm
Ugradni otvor Š x D	740 x 498 (R15)
Dubina korita	200 mm
Rub	standard

MARIS 2.0



MARIS 2.0 - MRG 620-35-35 - standardna ugradnja

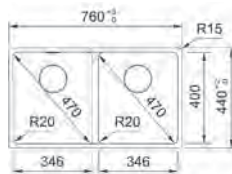
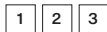

Završna obrada / FUN broj

114.0661.682
Crna mat

Ormar	800 mm
Dimenzije Š x D	760 x 440 mm
Ugradni otvor Š x D	740 x 428 (R15)
Dubina korita	200 mm
Rub	standard

MARIS 2.0 - MRG 620-35-35 TL - standardna ugradnja

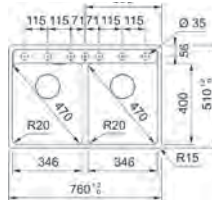
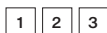

Završna obrada / FUN broj

114.0661.674
Crna mat

Ormar	800 mm
Dimenzije Š x D	760 x 510 mm
Ugradni otvor Š x D	740 x 498 (R15)
Dubina korita	200 mm
Rub	standard

MARIS 2.0 - MRG 110-37 - ugradnja pod radnu ploču

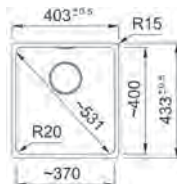

Završna obrada / FUN broj

125.0683.231
Crna mat

Ormar	450 mm
Dimenzije Š x D	403 x 433 mm
Ugradni otvor Š x D	vidi uputu
Dubina korita	200 mm
Rub	slim

MARIS 2.0 - MRG 110-52 - ugradnja pod radnu ploču

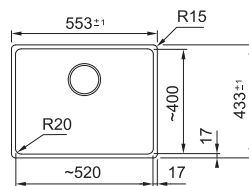
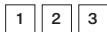

Završna obrada / FUN broj

125.0686.715
Crna mat

Ormar	600 mm
Dimenzije Š x D	553 x 433 mm
Ugradni otvor Š x D	vidi uputu
Dubina korita	200 mm
Rub	slim

MARIS 2.0 - MRG 110-62 - ugradnja pod radnu ploču

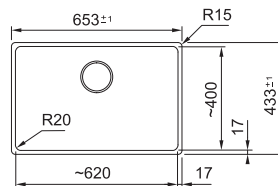
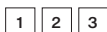

Završna obrada / FUN broj

125.0686.723
Crna mat

Ormar	700 mm
Dimenzije Š x D	653 x 433 mm
Ugradni otvor Š x D	vidi uputu
Dubina korita	200 mm
Rub	slim

MARIS 2.0 - MRG 110-72 - ugradnja pod radnu ploču

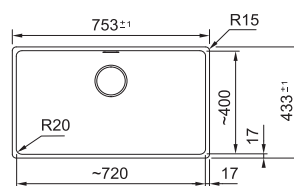
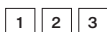

Završna obrada / FUN broj

125.0686.637
Crna mat

Ormar	800 mm
Dimenzije Š x D	753 x 433 mm
Ugradni otvor Š x D	vidi uputu
Dubina korita	200 mm
Rub	slim

MARIS 2.0

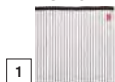

112.0030.882
Rollmat podložak



112.0188.651
Mobilni očeđivač

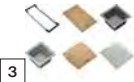

ALL-IN-ONE setovi
Više na str. 105

MARIS 2.0 - MRG 120-35-35 - ugradnja pod radnu ploču

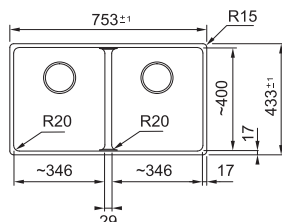

Završna obrada / FUN broj

125.0686.731
Crna mat

Ormar	800 mm
Dimenzije Š x D	753 x 433 mm
Ugradni otvor Š x D	vidi uputu
Dubina korita	200 mm
Rub	slim

Kubus 2 Black collection



KUBUS 2 - KNG 120 - ugradnja pod radnu ploču



NOVO

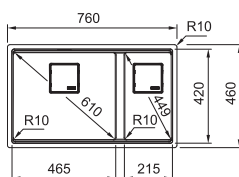

Završna obrada / FUN broj

125.0718.492
Crna mat

Ormar	800 mm
Dimenzije Š x D	760 x 460 mm
Ugradni otvor Š x D	vidi upute
Dubina korita	200 mm
Rub	slim

MARIS 2.0



112.0030.882
Rollmat podložak

112.0188.651
Mobilni ocjeđivač

ALL-IN-ONE setovi
Više na str. 105

KUBUS 2



112.0066.060
Kadica/cjedilo inox

112.0256.867
Rollmat podložka

112.0654.748
Daska za rezanje

Maris 2.0



MARIS 2.0 - MRG 610-37 TLA - standardna ugradnja

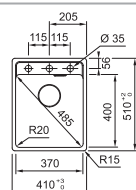
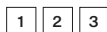

Ormar
Dimenzije Š x D
410 x 510 mm
Ugradni otvor Š x D
390 x 498 mm (R15)
Dubina korita
200 mm
Rub
standard



Završna obrada / FUN broj

	114.0658.254 Crna mat		114.0658.256 Glečer bijela
	114.0658.140 Crna		114.0658.257 Kašmir
	114.0658.255 Kameno siva		

MARIS 2.0 - MRG 610-52 TLA - standardna ugradnja

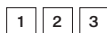

Ormar
Dimenzije Š x D
560 x 510 mm
Ugradni otvor Š x D
540 x 498 mm (R15)
Dubina korita
200 mm
Rub
standard



Završna obrada / FUN broj

	114.0658.294 Crna mat		114.0658.296 Glečer bijela
	114.0658.293 Crna		114.0658.297 Kašmir
	114.0658.295 Kameno siva		

MARIS 2.0 - MRG 610-72 TLA - standardna ugradnja

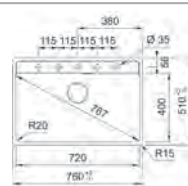
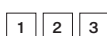

Ormar
Dimenzije Š x D
760 x 510 mm
Ugradni otvor Š x D
740 x 498 mm (R15)
Dubina korita
200 mm
Rub
standard



Završna obrada / FUN broj

	114.0658.305 Crna mat		114.0658.303 Crna
--	--------------------------	--	----------------------

MARIS 2.0

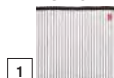

112.0030.882
Rollmat podložak



112.0188.651
Mobilni ocjeđivač



ALL-IN-ONE setovi
Više na str. 105

MARIS 2.0 - MRG 110-52 A - ugradnja pod radnu ploču



1 2 3

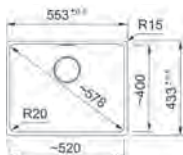

Ormar 600 mm
Dimenzije Š x D 553 x 433 mm
Ugradni otvor Š x D 520x400 (R20)
Dubina korita 200 mm
Rub slim



Završna obrada / FUN broj

	125.0683.105 Crna mat		125.0683.103 Glečer bijela
	125.0683.101 Crna		125.0683.104 Kašmir
	125.0683.102 Kameno siva		

MARIS 2.0 - MRG 610-52 - standardna ugradnja



1 2 3

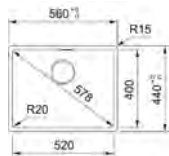

Ormar 600 mm
Dimenzije Š x D 560 x 440 mm
Ugradni otvor Š x D 540 x 428 mm (R15)
Dubina korita 200 mm
Rub standard



Završna obrada / FUN broj

	114.0661.659 Crna		114.0661.662 Glečer bijela
--	----------------------	--	-------------------------------

MARIS 2.0 - MRG 610-52 TL - standardna ugradnja



1 2 3

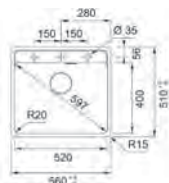

Ormar 600 mm
Dimenzije Š x D 560 x 510 mm
Ugradni otvor Š x D 540 x 498 mm (R15)
Dubina korita 200 mm
Rub standard



Završna obrada / FUN broj

	114.0661.643 Crna		114.0661.647 Sahara
	114.0661.644 Kameno siva		114.0661.648 Kašmir
	114.0661.646 Glečer bijela		

MARIS 2.0 - MRG 110-37 - ugradnja pod radnu ploču



1 2 3



Ormar 450 mm
Dimenzije Š x D 403 x 433 mm
Ugradni otvor Š x D vidi uputu
Dubina korita 200 mm
Rub slim



Završna obrada / FUN broj

	125.0683.139 Crna mat		125.0683.137 Glečer bijela
	125.0683.135 Crna		125.0683.138 Kašmir
	125.0683.136 Kameno siva		

MARIS 2.0 - MRG 110-52 - ugradnja pod radnu ploču



1 2 3

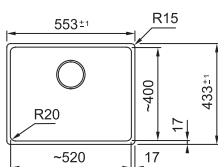

Ormar 600 mm
Dimenzije Š x D 553 x 433 mm
Ugradni otvor Š x D vidi uputu
Dubina korita 200 mm
Rub slim



Završna obrada / FUN broj

	125.0686.716 Crna		125.0686.720 Sahara
	125.0686.717 Kameno siva		125.0686.721 Kašmir
	125.0686.719 Glečer bijela		

MARIS 2.0 - MRG 110-62 - ugradnja pod radnu ploču



1 2 3

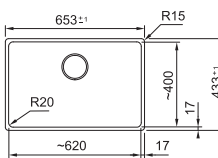

Ormar 700 mm
Dimenzije Š x D 653 x 433 mm
Ugradni otvor Š x D vidi uputu
Dubina korita 200 mm
Rub slim



Završna obrada / FUN broj

	125.0686.724 Crna		125.0686.728 Sahara
	125.0686.725 Kameno siva		125.0686.729 Kašmir
	125.0686.727 Glečer bijela		

MARIS 2.0

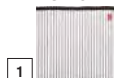

112.0030.882
Rollmat podložak



112.0188.651
Mobilni ocjeđivač



ALL-IN-ONE setovi
Više na str. 105

MARIS 2.0 - MRG 110-72 - ugradnja pod radnu ploču



1 2 3

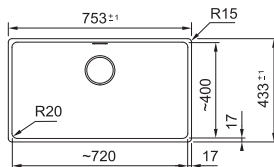

Ormar 800 mm
 Dimenzije Š x D 753 x 433 mm
 Ugradni otvor Š x D vidi uputu
 Dubina korita 200 mm
 Rub slim

Završna obrada / FUN broj

 125.0686.638 Crna	 125.0686.712 Sahara
 125.0686.639 Kameno siva	 125.0686.713 Kašmir
 125.0686.711 Glečer bijela	



MARIS 2.0

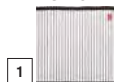

112.0030.882
Rollmat podložak



112.0188.651
Mobilni ocjeđivač

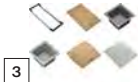

ALL-IN-ONE setovi
Više na str. 105

Maris



MARIS - MRG 610-54 FTL - standardna ugradnja



1 2



Ormar **600 mm**
 Dimenzije Š x D **590 x 500 mm**
 Ugradni otvor Š x D **570 x 480 mm**
 Dubina korita **200 mm**
 Rub **slim**



Završna obrada / FUN broj

	114.0661.699 Crna mat		114.0661.705 Sahara
	114.0661.703 Crna		114.0661.700 Avena
	114.0661.702 Kameno siva		114.0661.701 Kašmir
	114.0661.698 Glečer bijela		

MARIS - MRG 610-73 FTL - standardna ugradnja



1 2

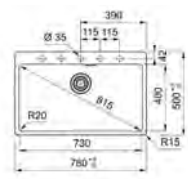

Ormar **800 mm**
 Dimenzije Š x D **780 x 500 mm**
 Ugradni otvor Š x D **760 x 480 mm**
 Dubina korita **200 mm**
 Rub **slim**



Završna obrada / FUN broj

	114.0661.707 Crna mat		114.0661.713 Sahara
	114.0661.711 Crna		114.0661.708 Avena
	114.0661.710 Kameno siva		114.0661.709 Kašmir
	114.0661.706 Glečer bijela		

MARIS - MRG 620-39-39 FTL - standardna ugradnja



1 2

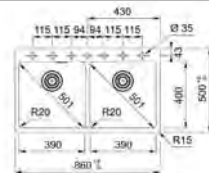

Ormar **900 mm**
 Dimenzije Š x D **860 x 500 mm**
 Ugradni otvor Š x D **840 x 480 mm**
 Dubina korita **200 mm**
 Rub **slim**



Završna obrada / FUN broj

	114.0666.362 Crna mat		114.0666.368 Sahara
	114.0666.363 Crna		114.0666.370 Avena
	114.0666.364 Kameno siva		114.0666.369 Kašmir
	114.0666.366 Glečer bijela		

MARIS



1 112.0030.882
Rollmat podložak

2 ALL-IN-ONE setovi
Više na str. 105

Kubus 2





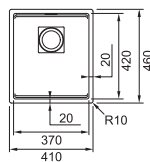

KUBUS 2 - KNG 110-37 - ugradnja pod radnu ploču



Ormar **450 mm**
 Dimenzije Š x D **410 x 460 mm**
 Ugradni otvor Š x D **370 x 420 mm (R10)**
 Dubina korita **200 mm**
 Rub **slim**



Završna obrada / FUN broj

 125.0627.320 Crna mat	 125.0512.451 Glečer bijela
 125.0512.449 Crna	 125.0512.450 Kašmir
 125.0512.452 Kameno siva	



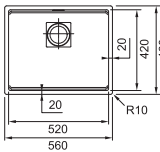

KUBUS 2 - KNG 110-52 - ugradnja pod radnu ploču



Ormar **600 mm**
 Dimenzije Š x D **560 x 460 mm**
 Ugradni otvor Š x D **520 x 420 mm (R10)**
 Dubina korita **200 mm**
 Rub **slim**



Završna obrada / FUN broj

 125.0627.319 Crna mat	 125.0512.506 Glečer bijela
 125.0512.504 Crna	 125.0512.505 Kašmir
 125.0512.507 Kameno siva	



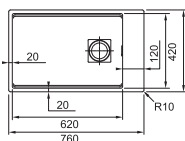

KUBUS 2 - KNG 110-62 - ugradnja pod radnu ploču



Ormar **800 mm**
 Dimenzije Š x D **760 x 460 mm**
 Ugradni otvor Š x D **720 x 420 mm (R10)**
 Dubina korita **200 mm**
 Rub **slim**



Završna obrada / FUN broj

 125.0627.321 Crna mat	 125.0512.517 Glečer bijela
 125.0512.515 Crna	 125.0512.516 Kašmir
 125.0512.518 Kameno siva	



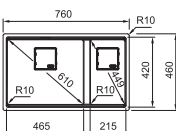

KUBUS 2 - KNG 120 - ugradnja pod radnu ploču



Ormar **800 mm**
 Dimenzije Š x D **760 x 460 mm**
 Ugradni otvor Š x D **720 x 420 mm (R10)**
 Dubina korita **200 mm**
 Rub **slim**



Završna obrada / FUN broj

 125.0529.871 Crna	 125.0529.858 Sahara
 125.0529.875 Kameno siva	 125.0529.872 Kašmir
 125.0529.874 Glečer bijela	

KUBUS 2 s daljinskim upravljačem



- | | | |
|-------------------------------------|----------------------------------|----------------------------------|
| 1 | 2 | 3 |
| 112.0066.060
Kadica/cjedilo inox | 112.0256.867
Rollmat podloška | 112.0654.748
Daska za rezanje |

Urban 2.0



URBAN 2.0 - UBG 610-50 A - standardna ugradnja



1 2

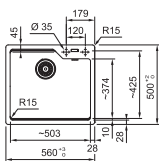

Ormar 600 mm
Dimenzije Š x D 560 x 500 mm
Ugradni otvor Š x D 540 x 480 mm (R15)
Dubina korita 220 mm
Rub slim top



Završna obrada	FUN broj
Crna mat	114.0682.641
Crna	114.0682.644
Glečer bijela	114.0682.600



URBAN 2.0 - UBG 610-50 - standardna ugradnja



1 2

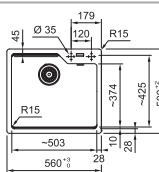

Ormar 600 mm
Dimenzije Š x D 560 x 500 mm
Ugradni otvor Š x D 540 x 480 mm (R15)
Dubina korita 230 mm
Rub slim top



Završna obrada / FUN broj	
114.0686.798 Crna mat	114.0686.796 Glečer bijela
114.0686.793 Crna	114.0686.791 Sahara
114.0686.797 Kameno siva	114.0686.794 Kašmir

URBAN 2.0 - UBG 610-72 - standardna ugradnja



1 2

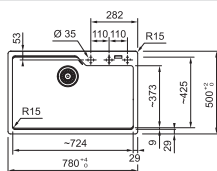

Ormar 800 mm
Dimenzije Š x D 780 x 500 mm
Ugradni otvor Š x D 760 x 480 mm (R15)
Dubina korita 230 mm
Rub slim top



Završna obrada / FUN broj	
114.0686.806 Crna mat	114.0686.803 Glečer bijela
114.0686.801 Crna	114.0686.799 Sahara
114.0686.805 Kameno siva	114.0686.802 Kašmir

URBAN 2.0



1 112.0595.334 Daska za rezanje

2 ALL-IN-ONE setovi Više na str. 105

URBAN 2.0 - UBG 620-78 - standardna ugradnja

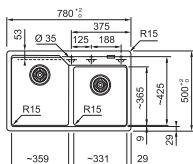

Ormar **800 mm**
 Dimenzije Š x D **780 x 500 mm**
 Ugradni otvor Š x D **760 x 480 mm (R15)**
 Dubina korita **220 mm / 200 mm**
 Rub **slim top**



Završna obrada / FUN broj

114.0686.764 Crna	114.0686.762 Sahara
114.0686.767 Kameno siva	114.0686.763 Avena
114.0686.766 Glečer bijela	114.0686.765 Kašmir

URBAN 2.0 - UBG 620-86 - standardna ugradnja

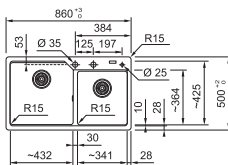

Ormar **900 mm**
 Dimenzije Š x D **860 x 500 mm**
 Ugradni otvor Š x D **840 x 480 mm (R15)**
 Dubina korita **230 mm / 220 mm**
 Rub **slim top**



Završna obrada / FUN broj

114.0686.775 Crna	114.0686.769 Sahara
114.0686.773 Kameno siva	114.0686.770 Avena
114.0686.768 Glečer bijela	114.0686.772 Kašmir

Pamira



PAMIRA - ROG 610-41 - standardna ugradnja

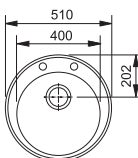

Ormar **450 mm**
 Dimenzije Š x D **Ø 510 mm**
 Ugradni otvor Š x D **Ø 493 mm**
 Dubina korita **195 mm**
 Rub **standard**



Završna obrada / FUN broj

114.0199.717 Crna	114.0009.509 Glečer bijela
114.0009.505 Kameno siva	114.0009.506 Avena

URBAN 2.0



1
 112.0595.334
 Daska za rezanje



2
 ALL-IN-ONE setovi
 Više na str. 105

Sudoperi od



fragranita



Sudoperi od fragranita

Standardna ugradnja



Centro 2.0
CNG 611-62 A
620 x 500 mm
str. 80



Centro 2.0
CNG 611-78 A
780 x 500 mm
str. 80



Urban 2.0
UBG 611-62 A
620 x 500 mm
str. 81



Urban 2.0
UBG 611-78 A
780 x 500 mm
str. 81



Urban 2.0
UBG 611-78 XL
780 x 500 mm
str. 81



Urban 2.0
UBG 611-86 A
860 x 500 mm
str. 82



Urban 2.0
UBG 611-100 A
1000 x 500 mm
str. 82



Urban 2.0
UBG 651-100
1000 x 500 mm
str. 82



Mythos
MTG 611
1000 x 515 mm
str. 83



Fresno
FSG 611-88
877 x 495 mm
str. 83



Centro 2.0
CNG 611-62 A
620 x 500 mm
str. 84



Centro 2.0
CNG 611-78 A
780 x 500 mm
str. 84



Maris
MRG 611-62
620 x 500 mm
str. 85



Maris
MRG 611-A
780 x 500 mm
str. 85



Maris
MRG 611-100
970 x 500 mm
str. 85



Maris
MRG 611-78 XL
780 x 500 mm
str. 85



Maris
MRG 611-100 XL
970 x 500 mm
str. 86



Maris
MRG 651-78
780 x 500 mm
str. 86



Maris
MRG 651-A
970 x 500 mm
str. 86



Maris
MRG 611
780 x 500 mm
str. 86

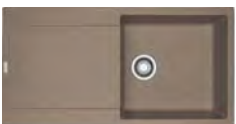

Maris
MRG 611-L
970 x 500 mm
str. 86



Maris
MRG 651
970 x 500 mm
str. 87



Maris
MRG 621
1160 x 500 mm
str. 87



Urban 2.0
UBG 611-62 A
620 x 500 mm
str. 88



Urban 2.0
 UBG 611-78 A
 780 x 500 mm
str. 88



Urban 2.0
 UBG 611-78 XL
 780 x 500 mm
str. 88



Urban 2.0
 UBG 611-86 A
 860 x 500 mm
str. 89



Urban 2.0
 UBG 611-100 A
 1000 x 500 mm
str. 89



Urban 2.0
 UBG 651-100
 1000 x 500 mm
str. 89



Urban 2.0
 UBG 611-62
 620 x 500 mm
str. 89



Urban 2.0
 UBG 611-78
 780 x 500 mm
str. 89



Urban 2.0
 UBG 611-86
 860 x 500 mm
str. 89



Basis
 BFG 611-62
 620 x 500 mm
str. 90



Basis
 BFG 611-78
 780 x 500 mm
str. 90



Basis
 BFG 611-86 A
 860 x 500 mm
str. 91



Basis
 BFG 651-78
 780 x 500 mm
str. 91



Basis
 BFG 651-A
 970 x 500 mm
str. 91



Boston
 BFG 611-78
 780 x 500 mm
str. 92



Boston
 BFG 611-86
 860 x 500 mm
str. 92



Boston
 BFG 611-97
 970 x 500 mm
str. 92



Boston
 BFG 651
 970 x 500 mm
str. 92



Boston
 BFG 620
 860 x 500 mm
str. 93

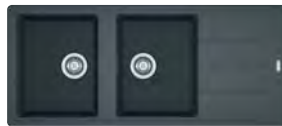

Boston
 BFG 621
 1160 x 500 mm
str. 93



Strata
 STG 614-78
 780 x 435 mm
str. 93



Strata
 STG 614
 860 x 435 mm
str. 93

Centro 2.0

Black collection



CENTRO 2.0 - CNG 611-62 A - standardna ugradnja



1 2

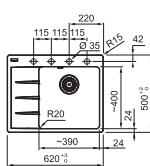

Ormar 450 mm
 Dimenzije Š x D 620 x 500 mm
 Ugradni otvor Š x D 600 x 480 mm (R15)
 Dubina korita 200 mm
 Rub standard



Završna obrada

Crna mat

FUN broj

114.0658.594

114.0658.595



CENTRO 2.0 - CNG 611-78 A - standardna ugradnja



1 2

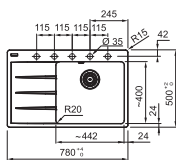

Ormar 600 mm
 Dimenzije Š x D 780 x 500 mm
 Ugradni otvor Š x D 760 x 480 mm (R15)
 Dubina korita 200 mm
 Rub standard



Završna obrada

Crna mat

FUN broj

114.0658.592

114.0658.593



CENTRO 2.0 s daljinskim upravljačem

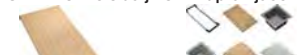

1
 112.0595.334
 Daska za rezanje

2
 ALL-IN-ONE setovi
 Više na str. 105

Urban 2.0

Black collection



URBAN 2.0 - UBG 611-62 A - standardna ugradnja



1 2 3 4 5

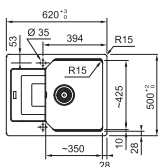

Ormar 450 mm
Dimenzije Š x D 620 x 500 mm
Ugradni otvor Š x D 600 x 480 mm (R15)
Dubina korita 220 mm
Rub standard



Završna obrada

Crna mat

FUN broj

114.0682.735



URBAN 2.0 - UBG 611-78 A - standardna ugradnja



1 2 3 4 5

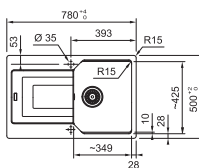

Ormar 450 mm
Dimenzije Š x D 780 x 500 mm
Ugradni otvor Š x D 760 x 480 mm (R15)
Dubina korita 220 mm
Rub standard



Završna obrada

Crna mat

FUN broj

114.0682.736



URBAN 2.0 - UBG 611-78 XL - standardna ugradnja



1 2 3 4 5

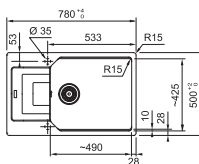

Ormar 600 mm
Dimenzije Š x D 780 x 500 mm
Ugradni otvor Š x D 760 x 480 mm (R15)
Dubina korita 220 mm
Rub standard



Završna obrada

Crna mat

FUN broj

114.0682.737



URBAN 2.0



URBAN 2.0 - UBG 611-86 A - standardna ugradnja

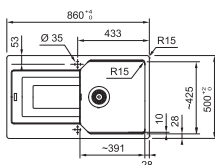
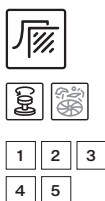

Ormar 500 mm
 Dimenzije Š x D 860 x 500 mm
 Ugradni otvor Š x D 840 x 480 mm (R15)
 Dubina korita 220 mm
 Rub standard

Završna obrada

Crna mat

FUN broj

114.0682.732



URBAN 2.0 - UBG 611-100 A - standardna ugradnja

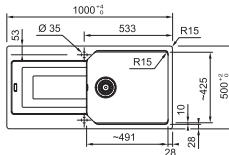
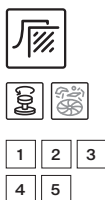

Ormar 600 mm
 Dimenzije Š x D 1000 x 500 mm
 Ugradni otvor Š x D 980 x 480 mm (R15)
 Dubina korita 220 mm
 Rub standard

Završna obrada

Crna mat

FUN broj

114.0682.733



URBAN 2.0 - UBG 651-100 - standardna ugradnja

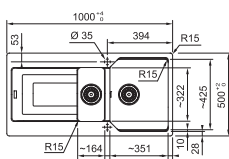

Ormar 600 mm
 Dimenzije Š x D 1000 x 500 mm
 Ugradni otvor Š x D 980 x 480 mm (R15)
 Dubina korita 220 mm / 140 mm
 Rub standard

Završna obrada

Crna mat

FUN broj

114.0682.734



URBAN 2.0



Mythos



MYTHOS - MTG 611 - standardna ugradnja

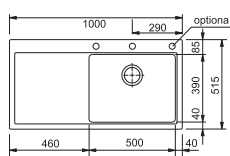

Završna obrada



Crna

FUN broj

114.0476.996
114.0476.995



Ormar 600 mm
Dimenzije Š x D 1000 x 515 mm
Ugradni otvor Š x D 980 x 495 mm (R25)
Dubina korita 190 mm
Rub standard

Fresno



FRESNO - FSG 611-88 - standardna ugradnja

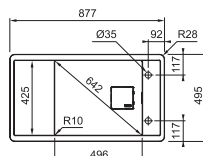

Završna obrada / FUN broj



114.0627.323
Crna mat



Ormar 600 mm
Dimenzije Š x D 877 x 495 mm
Ugradni otvor Š x D 845 x 463 mm (R20)
Dubina korita 195 mm
Rub standard

MYTHOS



FRESNO



Centro 2.0



CENTRO 2.0 - CNG 611-62 A - standardna ugradnja

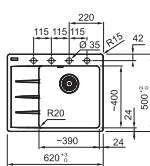

Ormar **450 mm**
 Dimenzije Š x D **620 x 500 mm**
 Ugradni otvor Š x D **600 x 480 mm (R15)**
 Dubina korita **200 mm**
 Rub **standard**



Završna obrada

- Crna mat
- Crna
- Kameno siva
- Glečer bijela
- Kašmir

FUN broj

- 114.0627.619
- 114.0627.618
- 114.0627.656
- 114.0627.655
- 114.0627.672
- 114.0627.671
- 114.0685.107
- 114.0685.106
- 114.0685.109
- 114.0685.108

CENTRO 2.0 - CNG 611-78 A - standardna ugradnja

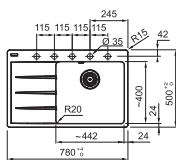

Ormar **600 mm**
 Dimenzije Š x D **780 x 500 mm**
 Ugradni otvor Š x D **760 x 480 mm (R15)**
 Dubina korita **200 mm**
 Rub **standard**



Završna obrada

- Crna mat
- Crna
- Kameno siva
- Glečer bijela
- Kašmir

FUN broj

- 114.0627.651
- 114.0627.620
- 114.0627.658
- 114.0627.657
- 114.0627.675
- 114.0627.674
- 114.0685.103
- 114.0685.102
- 114.0685.105
- 114.0685.104

CENTRO 2.0



1
 112.0595.334
 Daska za rezanje

2
 ALL-IN-ONE setovi
 Više na str. 105



MARIS - MRG 611-62 - standardna ugradnja



1 2 4

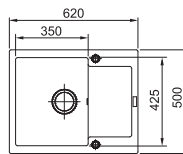

Ormar 450 mm
Dimenzije Š x D 620 x 500 mm
Ugradni otvor Š x D 600 x 480 mm
Dubina korita 200 mm
Rub standard



Završna obrada / FUN broj

114.0627.370 Crna mat	114.0253.323 Glečer bijela
114.0253.322 Crna	114.0302.708 Kašmir
114.0253.324 Kameno siva	



MARIS - MRG 611-A - standardna ugradnja



1 2 4

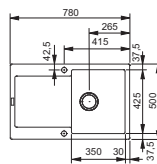

Ormar 450 mm
Dimenzije Š x D 780 x 500 mm
Ugradni otvor Š x D 760 x 480 mm
Dubina korita 200 mm
Rub standard



Završna obrada / FUN broj

114.0627.367 Crna mat	114.0055.697 Glečer bijela
114.0176.603 Crna	114.0302.705 Kašmir
114.0055.695 Kameno siva	



MARIS - MRG 611-100 - standardna ugradnja



1 2 3 4

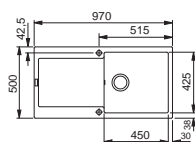

Ormar 600 mm
Dimenzije Š x D 970 x 500 mm
Ugradni otvor Š x D 950 x 480 mm
Dubina korita 200 mm
Rub standard



Završna obrada / FUN broj

114.0627.361 Crna mat	114.0176.596 Glečer bijela
114.0176.600 Crna	114.0302.693 Kašmir
114.0176.594 Kameno siva	



MARIS



1
112.0066.060
Kadica/cjedilo inox

2
112.0595.334
Daska za rezanje

3
112.0080.355
Rollmat podloška

4
ALL-IN-ONE setovi
Više na str. 105

MARIS - MRG 611-78 XL - standardna ugradnja

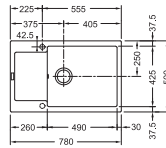

Ormar 600 mm
 Dimenzije Š x D 780 x 500 mm
 Ugradni otvor Š x D 760 x 480 mm
 Dubina korita 200 mm
 Rub standard



Završna obrada / FUN broj

	114.0627.365 Crna mat		114.0479.022 Glečer bijela
	114.0479.032 Crna		114.0479.027 Kašmir
	114.0479.030 Kameno siva		



MARIS - MRG 611-100 XL - standardna ugradnja

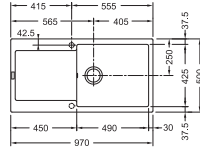

Ormar 600 mm
 Dimenzije Š x D 970 x 500 mm
 Ugradni otvor Š x D 950 x 480 mm
 Dubina korita 200 mm
 Rub standard



Završna obrada / FUN broj

	114.0627.363 Crna mat		114.0378.095 Glečer bijela
	114.0378.126 Crna		114.0378.121 Kašmir
	114.0378.124 Kameno siva		



MARIS - MRG 651-78 - standardna ugradnja

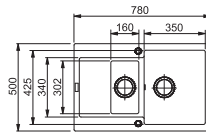

Ormar 600 mm
 Dimenzije Š x D 780 x 500 mm
 Ugradni otvor Š x D 760 x 480 mm
 Dubina korita 190 mm / 120 mm
 Rub standard



Završna obrada / FUN broj

	114.0627.289 Crna mat		114.0253.334 Glečer bijela
	114.0253.333 Crna		114.0302.683 Kašmir
	114.0253.335 Kameno siva		



MARIS - MRG 651-A - standardna ugradnja

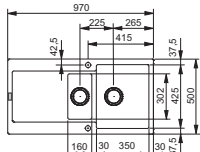

Ormar 600 mm
 Dimenzije Š x D 970 x 500 mm
 Ugradni otvor Š x D 950 x 480 mm (R11)
 Dubina korita 150 mm / 200 mm
 Rub standard



Završna obrada / FUN broj

	114.0627.286 Crna mat		114.0055.823 Glečer bijela
	114.0176.602 Crna		114.0302.676 Kašmir
	114.0055.819 Kameno siva		



MARIS - MRG 611 - standardna ugradnja

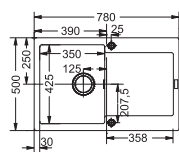

Ormar 450 mm (600 završni)
 Dimenzije Š x D 780 x 500 mm
 Ugradni otvor Š x D 760 x 480 mm
 Dubina korita 200 mm
 Rub standard



Završna obrada / FUN broj

	114.0630.781 Crna mat		114.0153.909 Glečer bijela
	114.0157.493 Crna		114.0066.567 Sahara
	114.0066.566 Kameno siva		114.0490.279 Kašmir



MARIS - MRG 611-L - standardna ugradnja

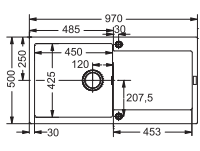

Ormar 600 mm
 Dimenzije Š x D 970 x 500 mm
 Ugradni otvor Š x D 950 x 480 mm
 Dubina korita 200 mm
 Rub standard



Završna obrada / FUN broj

	114.0630.730 Crna mat		114.0153.910 Glečer bijela
	114.0157.482 Crna		114.0490.280 Kašmir
	114.0066.570 Kameno siva		



MARIS



MARIS - MRG 651 - standardna ugradnja

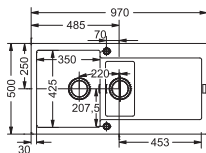
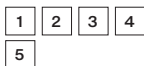

Ormar
Dimenzije Š x D
Ugradni otvor Š x D
Dubina korita
Rub

600 mm (800 završni)
970 x 500 mm
950 x 480 mm
200 mm / 130 mm
standard

Završna obrada / FUN broj

 114.0630.885 Crna mat	 114.0153.911 Glečer bijela
 114.0157.500 Crna	 114.0066.684 Sahara
 114.0066.682 Kameno siva	 114.0490.331 Kašmir



MARIS - MRG 621 - standardna ugradnja

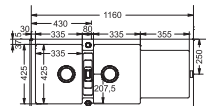

Ormar
Dimenzije Š x D
Ugradni otvor Š x D
Dubina korita
Rub

800 mm
1160 x 500 mm
1140 x 480 mm
200 mm
standard

Završna obrada / FUN broj

 114.0630.884 Crna mat	 114.0153.948 Glečer bijela
 114.0157.498 Crna	 114.0066.717 Sahara
 114.0066.716 Kameno siva	 114.0490.332 Kašmir



MARIS



A 1
112.0057.214
Kadica/cjedilo inox

2
112.0066.060
Kadica/cjedilo inox

3
112.0595.334
Daska za rezanje

4
112.0080.355
Rollmat podloška

5
ALL-IN-ONE setovi
Više na str. 105

Urban 2.0



URBAN 2.0 - UBG 611-62 A - standardna ugradnja



1 2 3 4 5

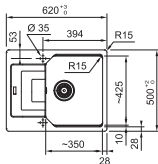

Ormar 450 mm
Dimenzije Š x D 620 x 500 mm
Ugradni otvor Š x D 600 x 480 mm (R15)
Dubina korita 220 mm
Rub slim top



Završna obrada	FUN broj
Crna mat	114.0682.546
Crna	114.0682.549
Kameno siva	114.0682.548
Glečer bijela	114.0682.545
Kašmir	114.0682.547



URBAN 2.0 - UBG 611-78 A - standardna ugradnja



1 2 3 4 5

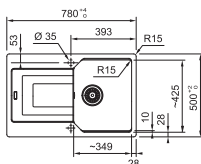

Ormar 450 mm
Dimenzije Š x D 780 x 500 mm
Ugradni otvor Š x D 760 x 480 mm (R15)
Dubina korita 220 mm
Rub slim top



Završna obrada	FUN broj
Crna mat	114.0682.561
Crna	114.0682.564
Kameno siva	114.0682.563
Glečer bijela	114.0682.550
Kašmir	114.0682.562



URBAN 2.0 - UBG 611-78 XL - standardna ugradnja



1 2 3 4 5

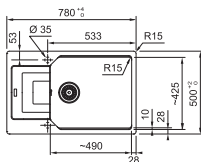

Ormar 600 mm
Dimenzije Š x D 780 x 500 mm
Ugradni otvor Š x D 760 x 480 mm (R15)
Dubina korita 220 mm
Rub slim top



Završna obrada	FUN broj
Crna mat	114.0682.566
Crna	114.0682.570
Kameno siva	114.0682.569
Glečer bijela	114.0682.565
Kašmir	114.0682.567



URBAN 2.0



1
112.0566.182
Kadica/cjedilo plastika

2
112.0066.060
Kadica/cjedilo inox

3
112.0595.334
Daska za rezanje

4
112.0256.867
Rollmat podloška

5
ALL-IN-ONE setovi
Više na str. 105

URBAN 2.0 - UBG 611-86 A - standardna ugradnja

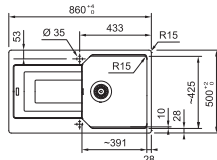

Ormar
Dimenzije Š x D **860 x 500 mm**
Ugradni otvor Š x D **840 x 480 mm (R15)**
Dubina korita **220 mm**
Rub **slim top**



Završna obrada	FUN broj
Crna mat	114.0682.521
Crna	114.0682.524
Kameno siva	114.0682.523
Glečer bijela	114.0682.510
Kašmir	114.0682.522



URBAN 2.0 - UBG 611-100 A - standardna ugradnja

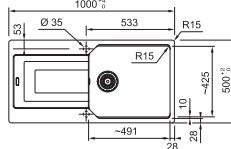
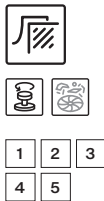

Ormar
Dimenzije Š x D **1000 x 500 mm**
Ugradni otvor Š x D **980 x 480 mm (R15)**
Dubina korita **220 mm**
Rub **slim top**



Završna obrada	FUN broj
Crna mat	114.0682.527
Crna	114.0682.530
Kameno siva	114.0682.529
Glečer bijela	114.0682.525
Kašmir	114.0682.528



URBAN 2.0 - UBG 651-100 - standardna ugradnja

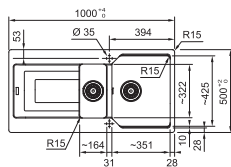

Ormar
Dimenzije Š x D **1000 x 500 mm**
Ugradni otvor Š x D **980 x 480 mm (R15)**
Dubina korita **220 mm**
Rub **slim top**



Završna obrada	FUN broj
Crna mat	114.0682.531
Crna	114.0682.534
Kameno siva	114.0682.533
Glečer bijela	114.0682.526
Kašmir	114.0682.532



URBAN 2.0 - UBG 611-62 - standardna ugradnja

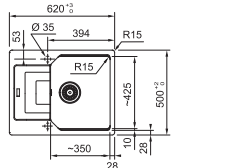
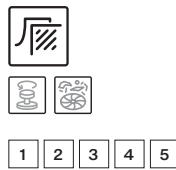

Ormar
Dimenzije Š x D **620 x 500 mm**
Ugradni otvor Š x D **600 x 480 mm (R15)**
Dubina korita **220 mm**
Rub **slim top**



Završna obrada / FUN broj	
114.0686.742 Crna	114.0686.740 Sahara
114.0686.745 Kameno siva	114.0686.741 Avena
114.0686.744 Glečer bijela	114.0686.743 Kašmir



URBAN 2.0 - UBG 611-78 - standardna ugradnja

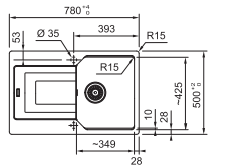
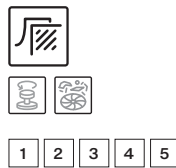

Ormar
Dimenzije Š x D **780 x 500 mm**
Ugradni otvor Š x D **760 x 480 mm (R15)**
Dubina korita **220 mm**
Rub **slim top**



Završna obrada / FUN broj	
114.0686.749 Crna	114.0686.747 Sahara
114.0686.752 Kameno siva	114.0686.748 Avena
114.0686.751 Glečer bijela	114.0686.750 Kašmir



URBAN 2.0 - UBG 611-86 - standardna ugradnja

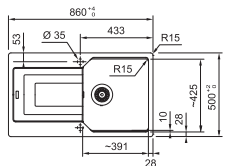
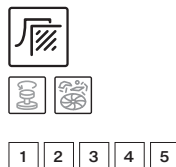

Ormar
Dimenzije Š x D **860 x 500 mm**
Ugradni otvor Š x D **840 x 480 mm (R15)**
Dubina korita **220 mm**
Rub **slim top**



Završna obrada / FUN broj	
114.0686.760 Crna	114.0686.754 Sahara
114.0686.758 Kameno siva	114.0686.755 Avena
114.0686.753 Glečer bijela	114.0686.757 Kašmir



URBAN 2.0



- 1 112.0566.182 Kadica/cjedilo plastika
- 2 112.0066.060 Kadica/cjedilo inox
- 3 112.0595.334 Daska za rezanje
- 4 112.0256.867 Rollmat podloška
- 5 ALL-IN-ONE setovi
Više na str. 105

Basis



BASIS - BFG 611-62 - standardna ugradnja



2 3

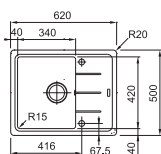

Ormar 450 mm
Dimenzije Š x D 620 x 500 mm
Ugradni otvor Š x D 600 x 480 mm (R20)
Dubina korita 200 mm
Rub standard



Završna obrada / FUN broj

 114.0301.331 Crna	 114.0301.342 Avena
 114.0301.333 Kameno siva	 114.0301.903 Kašmir
 114.0301.335 Glečer bijela	



BASIS - BFG 611-78 - standardna ugradnja



2 3

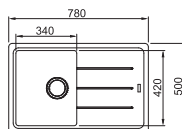

Ormar 450 mm
Dimenzije Š x D 780 x 500 mm
Ugradni otvor Š x D 760 x 480 mm (R20)
Dubina korita 200 mm
Rub standard



Završna obrada / FUN broj

 114.0256.610 Crna	 114.0256.609 Avena
 114.0256.612 Kameno siva	 114.0301.907 Kašmir
 114.0256.611 Glečer bijela	



BASIS



A
112.0250.014
Kadica/cjedilo inox

B
112.0595.334
Daska za rezanje

C
ALL-IN-ONE setovi
Više na str. 105

BASIS - BFG 611-86 A - standardna ugradnja

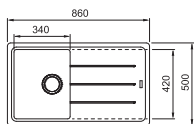

Ormar **450 mm**
 Dimenzije Š x D **860 x 500 mm**
 Ugradni otvor Š x D **840 x 480 mm (R20)**
 Dubina korita **200 mm**
 Rub **standard**



Završna obrada / FUN broj

- 114.0336.939 Crna
- 114.0336.914 Avena
- 114.0336.936 Kameno siva
- 114.0336.916 Kašmir
- 114.0336.417 Glečer bijela



BASIS - BFG 651-78 - standardna ugradnja

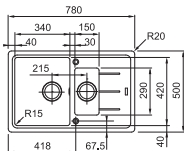

Ormar **600 mm**
 Dimenzije Š x D **780 x 500 mm**
 Ugradni otvor Š x D **760 x 480 mm (R20)**
 Dubina korita **200 mm / 90 mm**
 Rub **standard**



Završna obrada / FUN broj

- 114.0301.345 Crna
- 114.0301.370 Avena
- 114.0301.367 Kameno siva
- 114.0301.951 Kašmir
- 114.0301.368 Glečer bijela



BASIS - BFG 651-A - standardna ugradnja

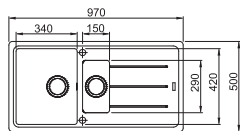

Ormar **600 mm**
 Dimenzije Š x D **970 x 500 mm**
 Ugradni otvor Š x D **950 x 480 mm (R20)**
 Dubina korita **200 mm / 90 mm**
 Rub **standard**



Završna obrada / FUN broj

- 114.0256.625 Crna
- 114.0256.624 Avena
- 114.0256.627 Kameno siva
- 114.0301.961 Kašmir
- 114.0256.626 Glečer bijela



BASIS



A 112.0250.014
Kadica/cjedilo inox



2 112.0595.334
Daska za rezanje



3 ALL-IN-ONE setovi
Više na str. 105

Boston



BOSTON - BFG 611-78 - standardna ugradnja



2 3

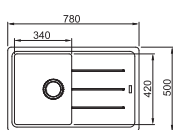

Ormar 450 mm
Dimenzije Š x D 780 x 500 mm
Ugradni otvor Š x D 760 x 480 mm
Dubina korita 200 mm
Rub standard



Završna obrada / FUN broj

114.0275.938 Crna
114.0275.955 Glečer bijela
114.0275.956 Avena



BOSTON - BFG 611-86 - standardna ugradnja



2 3

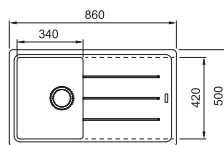

Ormar 450 mm
Dimenzije Š x D 860 x 500 mm
Ugradni otvor Š x D 840 x 480 mm
Dubina korita 200 mm
Rub standard



Završna obrada / FUN broj

114.0370.202 Crna
114.0370.205 Glečer bijela
114.0370.150 Sahara
114.0370.206 Avena



BOSTON - BFG 611-97 - standardna ugradnja



2 3

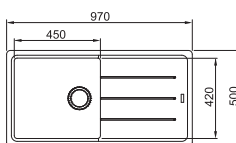

Ormar 600 mm
Dimenzije Š x D 970 x 500 mm
Ugradni otvor Š x D 950 x 480 mm
Dubina korita 200 mm
Rub standard



Završna obrada / FUN broj

114.0276.112 Crna
114.0276.119 Glečer bijela
114.0276.080 Sahara
114.0276.120 Avena



BOSTON - BFG 651 - standardna ugradnja



1 2 3

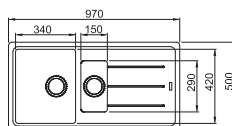

Ormar 600 mm
Dimenzije Š x D 970 x 500 mm
Ugradni otvor Š x D 950 x 480 mm
Dubina korita 200 mm / 100 mm
Rub standard



Završna obrada / FUN broj

114.0276.134 Crna
114.0276.136 Glečer bijela
114.0276.137 Avena
114.0490.338 Kašmir



BOSTON



112.0250.014
Kadica/cjedilo inox



112.0595.334
Daska za rezanje



ALL-IN-ONE setovi
Više na str. 105

BOSTON - BFG 620 - standardna ugradnja

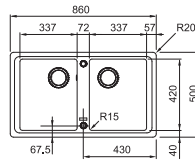

Ormar **800 mm (900 završni)**
 Dimenzije Š x D **860 x 500 mm**
 Ugradni otvor Š x D **840 x 480 mm**
 Dubina korita **200 mm**
 Rub **standard**



Završna obrada / FUN broj

- 114.0276.140 Crna
- 114.0276.152 Glečer bijela
- 114.0276.153 Avena
- 114.0490.337 Kašmir

BOSTON - BFG 621 - standardna ugradnja

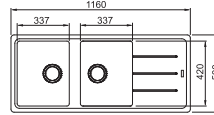

Ormar **800 mm**
 Dimenzije Š x D **1160 x 500 mm**
 Ugradni otvor Š x D **1140 x 480 mm**
 Dubina korita **200 mm**
 Rub **standard**



Završna obrada / FUN broj

- 114.0276.591 Crna
- 114.0276.593 Glečer bijela
- 114.0276.594 Avena
- 114.0490.339 Kašmir



Strata



STRATA - STG 614-78 - standardna ugradnja

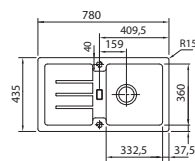

Ormar **450 mm**
 Dimenzije Š x D **780 x 435 mm**
 Ugradni otvor Š x D **760 x 415 mm (R20)**
 Dubina korita **165 mm**
 Rub **standard**



Završna obrada / FUN broj

- 114.0657.828 Crna mat
- 114.0303.670 Glečer bijela
- 114.0303.666 Crna
- 114.0303.672 Avena
- 114.0303.671 Kameno siva
- 114.0303.684 Kašmir



STRATA - STG 614 - standardna ugradnja

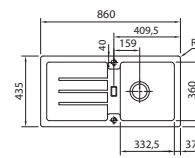

Ormar **450 mm**
 Dimenzije Š x D **860 x 435 mm**
 Ugradni otvor Š x D **840 x 415 mm (R20)**
 Dubina korita **165 mm**
 Rub **standard**



Završna obrada / FUN broj

- 114.0302.751 Crna
- 114.0302.750 Glečer bijela
- 114.0302.757 Avena
- 114.0302.762 Kašmir
- 114.0197.797 Kameno siva



STRATA



ALL-IN-ONE setovi
 Više na str. 105

Sudoperi

Standardna ugradnja



Sirius 2
SID 610-40
430 x 530 mm
str. 96



Sirius 2
SID 610
560 x 530 mm
str. 96



Sirius 2
S2D 611-62
620 x 500 mm
str. 96



Sirius 2
S2D 611-78
780 x 500 mm
str. 97



Sirius 2
S2D 611-78 XL
780 x 500 mm
str. 97



Sirius 2
S2D 611-100
1000 x 510 mm
str. 97



Single
Single 1
Ø 500 mm
str. 97



Tectonite®



Sirius 2



SIRIUS 2 - SID 610-40 - standardna ugradnja





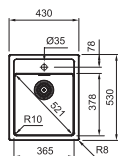

1



Ormar 450 mm
 Dimenzije Š x D 430 x 530 mm
 Ugradni otvor Š x D 410 x 510 mm
 Dubina korita 200 mm
 Rub standard

Završna obrada / FUN broj

 114.0500.019 Crna	 114.0499.970 Glečer bijela
 114.0500.012 Urban siva	 143.0675.501 Avena

SIRIUS 2 - SID 610 - standardna ugradnja





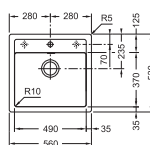

1



Ormar 600 mm
 Dimenzije Š x D 560 x 530 mm
 Ugradni otvor Š x D 540 x 510 mm
 Dubina korita 200 mm
 Rub standard

Završna obrada / FUN broj

 114.0368.467 Crna	 114.0368.449 Glečer bijela
 114.0463.958 Urban siva	 143.0675.481 Avena

SIRIUS 2 - S2D 611-62 - standardna ugradnja



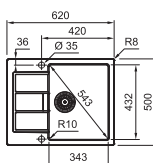

1



Ormar 450 mm
 Dimenzije Š x D 620 x 500 mm
 Ugradni otvor Š x D 600 x 480 mm
 Dubina korita 200 mm
 Rub standard

Završna obrada / FUN broj

 143.0616.339 Crna	 143.0616.341 Glečer bijela
 143.0616.345 Urban siva	

SIRIUS 2



1
 ALL-IN-ONE setovi
 Više na str. 105



SIRIUS 2 - S2D 611-78 - standardna ugradnja



1

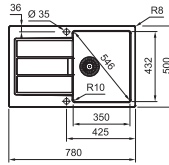

Ormar **450 mm**
 Dimenzije Š x D **780 x 500 mm**
 Ugradni otvor Š x D **760 x 480 mm**
 Dubina korita **200 mm**
 Rub **standard**

Završna obrada / FUN broj

143.0590.196 Crna
 143.0590.159 Glečer bijela
 143.0590.191 Urban siva



SIRIUS 2 - S2D 611-78 XL - standardna ugradnja



1

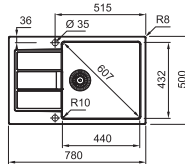

Ormar **600 mm**
 Dimenzije Š x D **780 x 500 mm**
 Ugradni otvor Š x D **760 x 480 mm**
 Dubina korita **200 mm**
 Rub **standard**

Završna obrada / FUN broj

143.0590.228 Crna
 143.0590.221 Glečer bijela
 143.0590.223 Urban siva



SIRIUS 2 - S2D 611-100 - standardna ugradnja



1

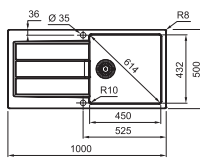

Ormar **600 mm**
 Dimenzije Š x D **1000 x 510 mm**
 Ugradni otvor Š x D **980 x 490 mm**
 Dubina korita **202 mm**
 Rub **standard**

Završna obrada / FUN broj

143.0590.212 Crna
 143.0590.205 Glečer bijela
 143.0590.207 Urban siva



Single 1

SINGLE - SINGLE 1 - standardna ugradnja

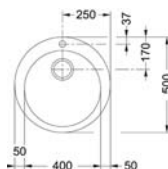

Ormar **600 mm**
 Dimenzije Š x D **500 mm**
 Ugradni otvor Š x D **480 mm**
 Dubina korita **155 mm**
 Rub **standard**

Završna obrada / FUN broj

114.0463.694 Crna
 114.0463.691 Glečer bijela
 114.0463.698 Urban siva
 143.0675.484 Avena

SIRIUS 2



1

ALL-IN-ONE setovi
 Više na str. 105

Sudoperi od keramike



amike



Standardna ugradnja



Mythos
MTK 610-58
580 x 510 mm
str. 100



Mythos
MTK 611-78
780 x 510 mm
str. 100



Mythos
MTK 611-100
1000 x 510 mm
str. 100



Mythos
MTK 651-100
1000 x 510 mm
str. 100



Maris
MRK 611-62
620 x 510 mm
str. 101



Maris
MRK 611-78
780 x 510 mm
str. 101



Maris
MRK 611-100
1000 x 510 mm
str. 101



Maris
MRK 651-100
1000 x 510 mm
str. 101

Ugradnja pod radnu ploču



Kubus
KBK 110-40
445 x 445 mm
str. 102



Kubus
KBK 110-50
545 x 445 mm
str. 102



Kubus
KBK 110-70
745 x 445 mm
str. 102

Mythos

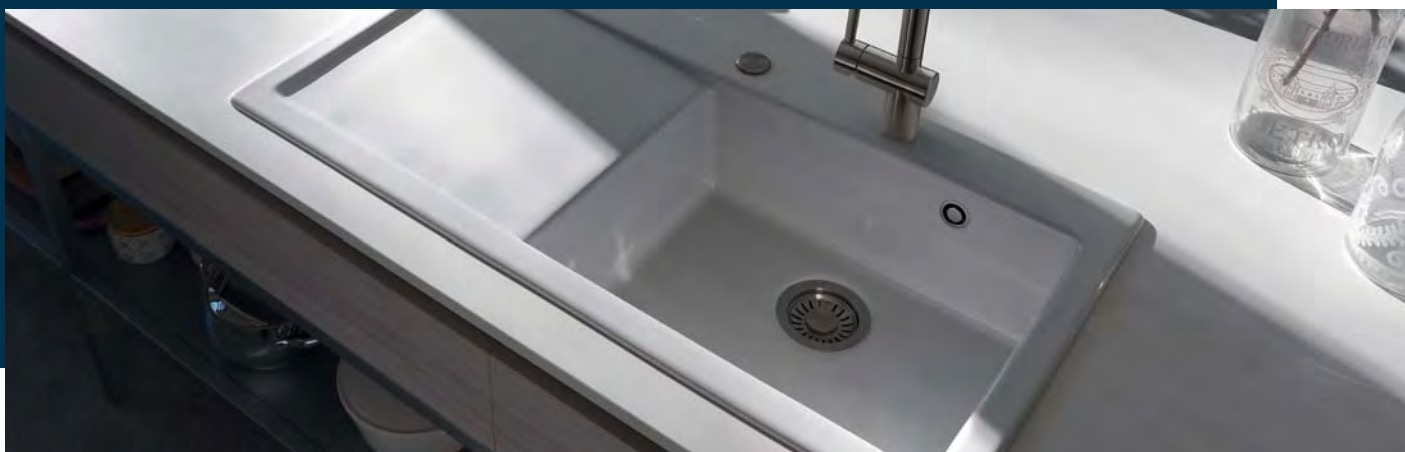

MYTHOS - MTK 610-58 - standardna ugradnja

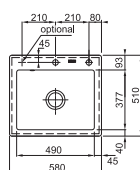





Ormar
Dimenzije Š x D
Ugradni otvor Š x D
Dubina korita
Rub

600 mm
580 x 510 mm
560 x 490 mm (R10)
190 mm
standard



Završna obrada / FUN broj

 124.0335.851*** Crna	 124.0335.844*** Magnolija
 124.0335.706*** Glečer bijela	 124.0380.250*** Antracit mat

***isključivo po narudžbi

MYTHOS - MTK 611-78 - standardna ugradnja

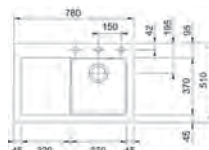

Ormar
Dimenzije Š x D
Ugradni otvor Š x D
Dubina korita
Rub

450 mm
780 x 510 mm
760 x 490 mm (R10)
190 mm
standard



Završna obrada / FUN broj 2 x 35 mm otvori

 Crna	124.0433.445***	
	124.0433.433***	
 Glečer bijela	124.0433.442***	
	124.0433.384***	
 Magnolija	124.0433.443***	
	124.0433.385***	

***isključivo po narudžbi

MYTHOS - MTK 611-100 - standardna ugradnja

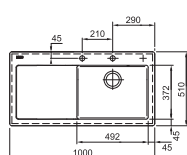

Ormar
Dimenzije Š x D
Ugradni otvor Š x D
Dubina korita
Rub

600 mm
1000 x 510 mm
980 x 490 mm (R10)
190 mm
standard



Završna obrada / FUN broj 2 x 35 mm otvori

 Crna	124.0335.863***	
	124.0335.856***	
 Glečer bijela	124.0335.708***	
	124.0335.707***	
 Magnolija	124.0335.859***	
	124.0335.853***	

***isključivo po narudžbi

MYTHOS - MTK 651-100 - standardna ugradnja

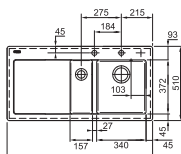

Ormar
Dimenzije Š x D
Ugradni otvor Š x D
Dubina korita
Rub

600 mm
1000 x 510 mm
980 x 490 mm (R10)
190 mm / 120 mm
standard



Završna obrada / FUN broj 2 x 35 mm otvori

 Crna	124.0335.872***	
	124.0335.868***	
 Glečer bijela	124.0335.710***	
	124.0335.709***	
 Magnolija	124.0335.870***	
	124.0335.865***	

***isključivo po narudžbi

MYTHOS



1 112.0030.882 Rollmat podložak
2 112.0256.867 Rollmat podloška



MARIS - MRK 611-62 - standardna ugradnja

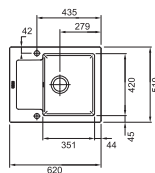

Ormar
Dimenzije Š x D
Ugradni otvor Š x D
Dubina korita
Rub

500 mm
620 x 510 mm
600 x 490 mm (R10)
200 mm
standard

Završna obrada / FUN broj

124.0335.692*** Crna
124.0335.678*** Glečer bijela
124.0335.694*** Magnolija

***isključivo po narudžbi



MARIS - MRK 611-78 - standardna ugradnja



Ormar
Dimenzije Š x D
Ugradni otvor Š x D
Dubina korita
Rub

450 mm
780 x 510 mm
760 x 490 mm (R10)
200 mm
standard

Završna obrada / FUN broj

124.0381.404*** Crna
124.0381.390*** Glečer bijela
124.0381.401*** Magnolija

***isključivo po narudžbi



MARIS - MRK 611-100 - standardna ugradnja

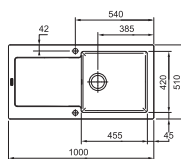

Ormar
Dimenzije Š x D
Ugradni otvor Š x D
Dubina korita
Rub

600 mm
1000 x 510 mm
980 x 490 mm (R10)
200 mm
standard

Završna obrada / FUN broj

124.0335.698*** Crna
124.0335.694*** Glečer bijela
124.0335.696*** Magnolija

***isključivo po narudžbi



MARIS - MRK 651-100 - standardna ugradnja

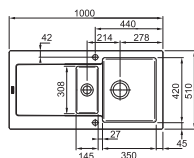

Ormar
Dimenzije Š x D
Ugradni otvor Š x D
Dubina korita
Rub

600 mm
1000 x 510 mm
980 x 490 mm (R10)
200 mm
standard

Završna obrada / FUN broj

124.0335.704*** Crna
124.0335.700*** Glečer bijela
124.0335.701*** Magnolija

***isključivo po narudžbi



MARIS



1
112.0325.251
Kadica/cjedilo inox

2
112.0654.748
Daska za rezanje

3
112.0256.867
Rollmat podloška

Kubus



KUBUS - KBK 110-40 - ugradnja pod radnu ploču

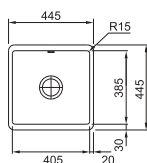

Ormar **500 mm**
 Dimenzije Š x D **445 x 445 mm**
 Ugradni otvor Š x D **395 x 375 mm (R15)**
 Dubina korita **185 mm**
 Rub **slim**



Završna obrada / FUN broj

126.0335.878*** Crna
 126.0335.875*** Magnolija
 126.0335.711*** Glečer bijela

***isključivo po narudžbi

KUBUS - KBK 110-50 - ugradnja pod radnu ploču

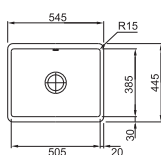

Ormar **600 mm**
 Dimenzije Š x D **545 x 445 mm**
 Ugradni otvor Š x D **495 x 375 mm (R15)**
 Dubina korita **185 mm**
 Rub **slim**



Završna obrada / FUN broj

126.0335.883*** Crna
 126.0335.712*** Glečer bijela
 126.0380.350*** Antracit mat
 126.0335.880*** Magnolija

***isključivo po narudžbi

KUBUS - KBK 110-70 - ugradnja pod radnu ploču

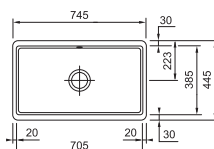

Ormar **800 mm**
 Dimenzije Š x D **745 x 445 mm**
 Ugradni otvor Š x D **695 x 375 mm (R15)**
 Dubina korita **185 mm**
 Rub **slim**



Završna obrada / FUN broj

126.0381.512*** Crna
 126.0381.440*** Magnolija
 126.0381.439*** Glečer bijela

***isključivo po narudžbi

KUBUS



1 112.0030.882
 Rollmat podložak

2 112.0188.653
 Mobilni ocjeđivač



Dodatni pribor







sudoperi

Drobnice otpada



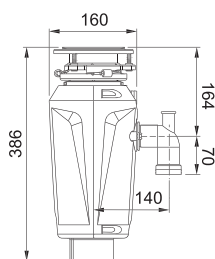

SLIM 125

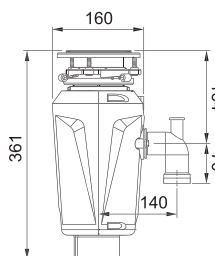

Završna obrada	FUN broj
 Nehrđajući čelik	134.0715.094
Komponente za drobljenje	Nehrđajući čelik
Snaga (KS)	1,25
Kapacitet komore	0,86 l
Težina	5,93 kg
Napomena	Pneumatski gumb uključen, antibakterijski tretman

SLIM 75



Završna obrada	FUN broj
 Nehrđajući čelik	134.0715.096
Komponente za drobljenje	Nehrđajući čelik
Snaga (KS)	0,75
Kapacitet komore	0,86 l
Težina	6,8 kg
Napomena	Pneumatski gumb uključen, antibakterijski tretman

SLIM 50

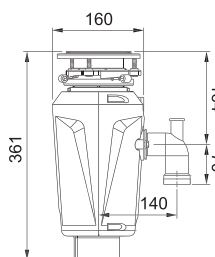

Završna obrada	FUN broj
 Nehrđajući čelik	134.0715.098
Komponente za drobljenje	Nehrđajući čelik
Snaga (KS)	0,50
Kapacitet komore	0,86 l
Težina	6,8 kg
Napomena	Pneumatski gumb uključen, antibakterijski tretman

ALL in ONE



reddot winner 2022



ALL-In-ONE set 1

FUN broj
112.0655.481

- Teleskopski držač
- Daska za rezanje od bambusa
- Velika kadica/cjedilo

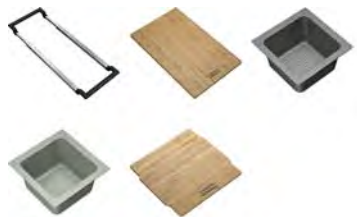

ALL-In-ONE set 2

FUN broj
112.0655.482

- Teleskopski držač
- Daska za rezanje od bambusa
- Mala kadica/cjedilo
- Mala kadica
- Poklopac od bambusa

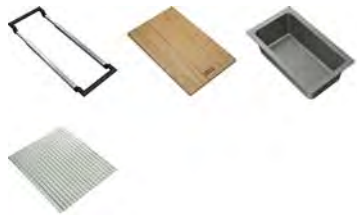

ALL-In-ONE set 3

FUN broj
112.0655.483

- Teleskopski držač
- Daska za rezanje od bambusa
- Velika kadica/cjedilo
- Mobilna prostirka za sušenje

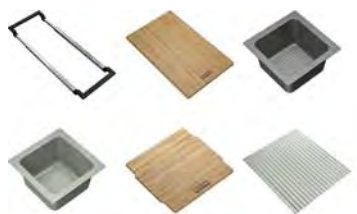

ALL-In-ONE set 4

FUN broj
112.0655.488

- Teleskopski držač
- Daska za rezanje od bambusa
- Mala kadica/cjedilo
- Mala kadica
- Poklopac od bambusa
- Mobilna prostirka za sušenje

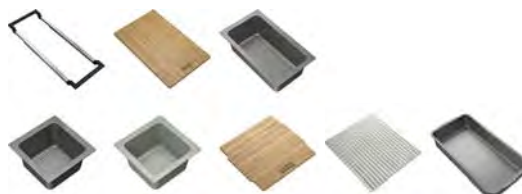

ALL-In-ONE set 5

FUN broj
112.0655.489

- Teleskopski držač
- Daska za rezanje od bambusa
- Velika kadica/cjedilo
- Mala kadica/cjedilo
- Mala kadica
- Poklopac od bambusa
- Mobilna prostirka za sušenje
- Posuda za skladištenje

Andy Chef



ANDY CHEF



Uredno i spremno za sljedeći dan

Andy Chef omogućuje da se pribor nakon ispiranja jednostavno može staviti u Franke Box sudoper da se osuši. Voda može otjecati ispod Andy Chefa.

Model	FUN broj
Andy Chef	112.0619.946

Pribor:

- posuda za cijedenje od nehrđajućeg čelika
- daska za rezanje od masivnog oraha
- oštar kuhinjski nož

Rollmat podloške



ROLLMAT PODLOŠKA



Model	FUN broj
Rollmat za MYTHOS, KUBUS, PLANAR	112.0030.882
Rollmat za MYTHOS, MARIS	112.0075.642
Rollmat za BOX	112.0080.355
Rollmat za KUBUS 2	112.0256.867

Dozatori tekućeg deterdženta



DOZATORI TEKUĆEG DETERDŽENTA SDR

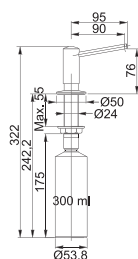

Model	FUN broj
Dozator SDR - krom	119.0150.262

DOZATORI TEKUĆEG DETERDŽENTA NOVITA

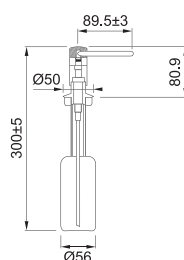

Model	FUN broj
Dozator Novita - nehrđajući čelik optik	119.0155.993

DOZATORI TEKUĆEG DETERDŽENTA NOVITA STEEL

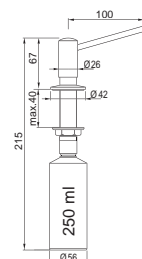

Model	FUN broj
Dozator Novita Steel - nehrđajući čelik	119.0177.893

DOZATORI TEKUĆEG DETERDŽENTA ACTIVE

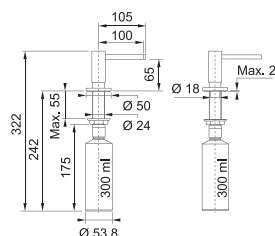

Model	FUN broj
Dozator Active - crna mat	119.0547.906

Dodaci

AUTOMATSKI SET ODVODA ZA SUDOPERE

1 Automatski set odvoda s premium košaricom SATINIRANA



2 Automatski set odvoda sa standardnom košaricom KROMIRANA



3 Automatski set odvoda sa standardnom košaricom CRNA MAT



Proizvod	FUN broj
Automatski set odvoda:	
1 za sudopere nehrđajući čelika za sudopere fragranit	112.0301.698 112.0389.090
2 za sudopere nehrđajući čelika za sudopere fragranit	112.0332.278 112.0544.161
3 za sudopere fragranit	112.0656.939

DALJINSKI UPRAVLJAČI ZA SUDOPERE

1 Daljinski otvarač pilete Push-Pull



2 Daljinski otvarač pilete Push-Pull



3 Daljinski otvarač pilete Push-Pull



4 Daljinski otvarač pilete zakretni



5 Daljinski otvarač pilete zakretni



Proizvod	FUN broj
Daljinski otvarač pilete za sudopere nehrđajući čelik i fragranit:	
1 Push-Pull - Satinirani	112.0705.730
2 Push-Pull - Kromirani	112.0611.460
3 Push-Pull - Crni mat	112.0705.753
4 Zakretni - Kromirani	133.0537.934
5 Zakretni - Crni mat	112.0657.383

DIJAMANTNA PILA



Model	FUN broj
Dijamantna pila za rupe za fragranit sudopere	112.0473.656

KOPČE



Model	FUN broj
4 kopče i podložna pločica	112.0068.252
6 kopči	112.0059.999
6 kopči i podložna pločica	112.0068.253
8 kopči	133.0048.423
8 kopči i podložna pločica	112.0073.250
10 kopči	133.0176.050
12 kopči i podložna pločica	112.0064.407
16 kopči za radne ploče debljine do 20 mm	133.0382.885

ROZETA



Model	FUN broj
Rozeta za zatvaranje rupe na sudoperu	112.0073.191

POKLOPAC ODVODA ZA SUDOPERE

1 Nehrdajući čelik



2 Plastika, crna



3 Nehrdajući čelik



4 Nehrdajući čelik, crna mat (premazan)



Model	FUN broj
Poklopac odvoda za sudoper:	
1 Nehrdajući čelik - za MYX, BWX i MRG (korita)	112.0532.169
2 Plastika, crna - za UBG i MRG (korita)	112.0657.146
3 Nehrdajući čelik - za KNG	112.0395.171
4 Nehrdajući čelik, crna mat (premazan) - za KNG	112.0670.893

Sredstva za čišćenje

SREDSTVO ZA ČIŠĆENJE SUDOPERA



Proizvod	FUN broj
Sredstvo za čišćenje sudopera od nehrđajućeg čelika - 200 ml	112.0530.237
Sredstvo za čišćenje fragranit, Tectonite® i keramičkih sudopera - 250 ml	112.0530.238

SREDSTVO ZA ČIŠĆENJE SUDOPERA - MARATHON



Proizvod	FUN broj
Tekućina za uklanjanje kamenca za čišćenje nehrđajućeg čelika i fragranita - 100 ml	
Pakiranje - 3 kom	112.0007.712

KRPA ZA ČIŠĆENJE



Proizvod	FUN broj
Krpa za čišćenje od mikrofibre	112.0530.324

VIŠENAMJENSKA PASTA



Proizvod	FUN broj
Višenamjenska pasta - 300 gr.	
Pakiranje - 1 kom	112.0158.200

SPUŽVICA ZA ČIŠĆENJE FRAGRANITA



Proizvod	FUN broj
Melaminska spužva za čišćenje fragranita	
Pakiranje - 3 kom	112.0304.193

Obrada



vode



Slavine za obradu vode



Water Hub
All In One
str. 116



Water Hub
Sparkling
str. 117

Slavine za filtriranu vodu



Vital Semi-pro
str. 122



Vital Semi-pro
str. 122

Mythos Water Hub

All in One / Sparkling



Uživajte u svojoj omiljenoj vodi samo jednim dodirirom

Možda ćete morati pronaći nove namjene za svoje posude za led, karbonator vode i kuhalo za vodu, zahvaljujući revolucionarnom Mythos Water Hubu. Ovaj inovativni kućni sustav All-in-One omogućuje vam jednostavan odabir i trenutni pristup željenoj vrsti vode, bilo da je filtrirana, gazirana, ohlađena ili kipuća.



Za svačiji ukus

Uz dizajn 6-u-1, vi i vaši gosti možete birati između tople ili hladne, filtrirane, ohlađene, gazirane i instant kipuće vode jednostavnim dodirirom slavine.



KOMPAKTNO
RJEŠENJE

Kompaktno i praktično

S višenamjenskim sustavom i kompaktnim dizajnom u jednoj kutiji, novi Mythos Water Hub opremljen je elektroničkim LED indikatorima za intuitivno i jednostavno upravljanje. Lako se postavlja ispod sudopera, oslobađajući prostor u kuhinji.

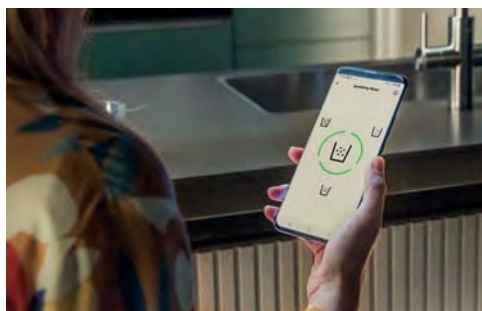

Ostanite povezani

Prilagodite svoje iskustvo s vodom putem naše aplikacije i dobijte pregled svoje potrošnje vode. Osim toga, možete praktično upravljati svojim narudžbama filtera, bilo kada i bilo gdje.

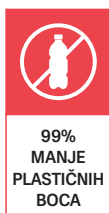

99%
MANJE
PLASTIČNIH
BOCA

Zdrav dom za zdraviji planet

S filtriranom i gaziranom vodom koja je lako dostupna, možete smanjiti potrebu za plastičnim bocama u svom domu do 99%. Mala gesta za održivu budućnost.



Potrošni materijal



Filter Pro M Connect

Sprječava nakupljanje kamenca u vašem uređaju, uklanja onečišćenja i čuva dobre minerale u vašoj vodi. RFID tehnologija integrirana u Franke uređaj obavještava vas kada treba zamijeniti filter.

Zamjenski filter
150.0717.797

CO2 boca

Izrađen od čelika i pod tlakom za siguran transport bez gubitka plina, ima sustav jednostavnog pričvršćivanja/odvajanja koji omogućuje jednostavnu zamjenu.

Set za dezinfekciju

Svakih 6 mjeseci i uređaj i aplikacija predložit će vam da izvršite čišćenje sustava pomoću određene kemijske tablete.

Set za dezinfekciju
112.0699.241

Mythos Water Hub All In One

Uživajte u svojoj omiljenoj vodi samo jednim dodirom

Kipućom, filtriranom, ohlađenom i gaziranom vodom upravlja se lijevim okretnim regulatorom



Nefiltrirana hladna i topla voda kontrolira se desnom polugom

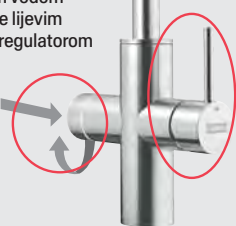

Pripravnost



Rashlađena voda



Gazirana voda



Kipuća voda



Voda ambientalne temperature



Blago gazirana voda

WATER HUB All In One

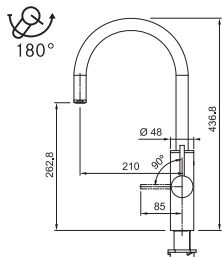

Značajke slavine

Promjer baze: 48 mm
Vrsta: Elektronička miješalica višenamjenska
Rotacija cijevi: 180°
Hod upravljačke poluge: 0_90
Crijeva: Inox
Keramički disk uložak: Ø 40
Protok (3 bara) l/min: 6,9 (vruće) - 6,1 (hladno) - 7,4 (mješovito)



reddot winner 2024

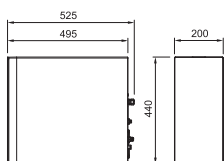

Značajke uređaja

Dimenzije (VxŠxD): 440x200x495 mm
Povezivost: Da, preko Franke@Home aplikacije

Bojler:

Kapacitet: 4 litre
Energetski razred: A
Snaga: 1725 W
Standby način: max 14 W
Vrijeme zagrijavanja: (100°C) 15 minuta *

Hladnjak/karbonator:

Kapacitet hladnjaka: 2,2 l
Kapacitet hladnjaka + karbonatora: 2,8 l
Vrijeme hlađenja: (20°C do 10°C) 8 minuta *



Završna obrada

Nehrdajući čelik

FUN broj

160.0708.955

Mythos Water Hub Sparkling

Uživajte u svojoj omiljenoj vodi samo jednim dodirrom



Pripravnost



Rashlađena voda



Gazirana voda



Voda ambientalne temperature



Blago gazirana voda

WATER HUB Sparkling

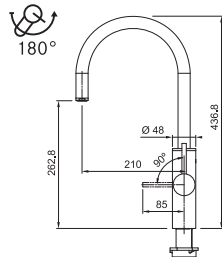

Značajke slavine

Promjer baze: 48 mm
Vrsta: Elektronička miješalica višenamjenska
Rotacija cijevi: 180°
Hod upravljačke poluge: 0_90
Crijeva: Inox
Keramički disk uložak: Ø 40
Protok (3 bara) l/min: 6,9 (vruće) - 6,1 (hladno) - 7,4 (mješovito)



reddot winner 2024

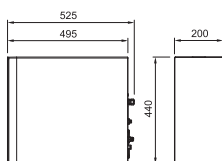

Značajke uređaja

Dimenzije (VxŠxD): 440x200x495 mm
Povezivost: Da, preko Franke@Home aplikacije

Bojler:

Kapacitet: 4 litre
Energetski razred: A
Snaga: 1725 W
Standby način: max 14 W
Vrijeme zagrijavanja (100°C): 15 minuta *

Hladnjak/karbonator:

Kapacitet hladnjaka: 2,2 l
Kapacitet hladnjaka + karbonatora: 2,8 l
Vrijeme hlađenja (20°C do 10°C): 8 minuta *



Završna obrada

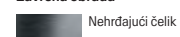

Nehrdajući čelik

FUN broj

160.0708.956

Slavine za filtriranu vodu



reddot design award
winner 2019

Za više informacija o sustavu
Vital Capsule i održavanju
filtera skenirajte ovaj QR kod.



Što Vital sustav čini tako korisnim?

Filter s kapsulom, mali, ali snažan.

Franke Vital filtrirajuća kapsula nije samo najmanji filter vode na svijetu nego i prvi koristi aktivni ugljen u kombinaciji s visoko tehnološkom membranom u svrhu temeljitog pročišćavanja vode. Ovisno o vašim potrebama korištenja, dostupan je u dvije varijante: **High Flow** i **High Performance**.

- Pijte pročišćenu vodu direktno iz kućne slavine
- Kompaktan dizajn, integriran izravno u slavinu, ne zahtjeva prostor ispod sudopera
- Uklanja onečišćenja dok mineralne soli ostaju u filtriranoj vodi
- LED svjetlo pokazuje kada je potrebno zamijeniti filter
- Zamjena filtera je brza i jednostavna

Uštedite novac i koristite manje plastike

Pomažući u smanjenju utjecaja na okoliš, sustav Vital omogućuje smanjenje otpada koji proizvode plastične boce za 99%* i pomaže obiteljima uštedjeti na potrošnji vode.

Parametri filtera

Opseg: 3.5L/ min pri 3 bara

Raspon temperature: 1 - 38°C (34 - 100°F)

Raspon tlaka: 1.0 - 6.8 bara (14.5 - 100 psi)

Kapacitet: do 500 L (132 galona), ovisno o tlaku i kvaliteti vode

* Osnova izračuna: težina kapsule Vital filtera = 33,5 g, prosječna masa PET boce od 1 litre = 35,0 g, 1 kapsula Vital filtera zamjenjuje 500 PET boca, zatim 33,5 g podijeljeno s 500 x 35, 0 g = 0,2%

Sustav Vital kapsula

Filter High Performance dizajniran za
pružanje kvalitetne i čiste vode

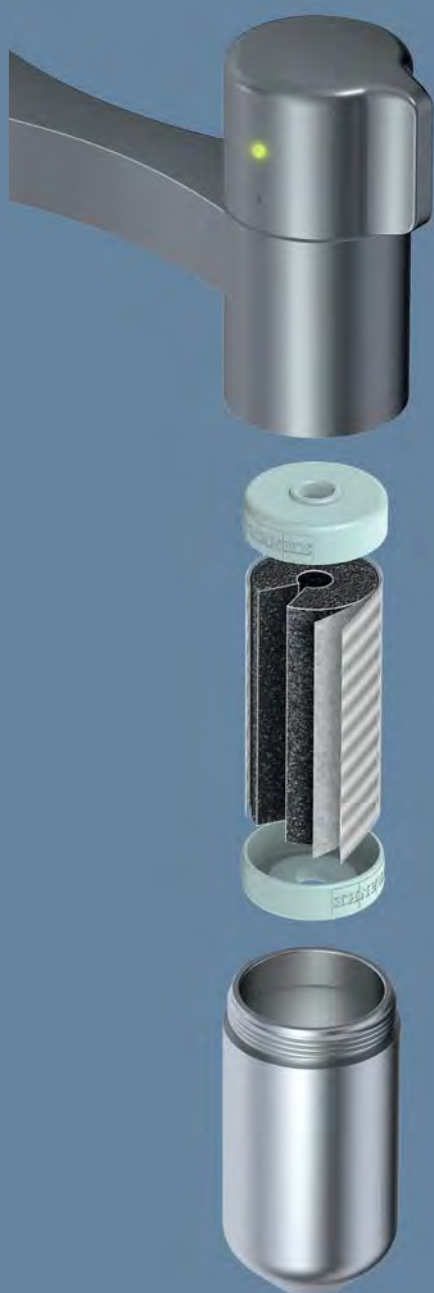

Naš sustav za filtriranje vode nije samo najmanji filter na svijetu, on je također prvi koji koristi učinkovitost aktivnog ugljena u kombinaciji s Franke patentiranom membranom.

■ Prefilter

Prefilter je prva crta obrane s ciljem uklanjanja grube kontaminacije. Veće čestice poput hrđe su zarobljene i zadržane.

■ Membrana*

Naša patentirana membrana (veličina pora 0,3 µm) djeluje kao štit od neželjenih / štetnih tvari. Membrana sprječava prolazak sedimenata, hrđe, mikroplastike pa čak i bakterija.

■ Filter s aktivnim ugljenom

Prirodno učinkovit filter, testiran desetljećima. Aktivni ugljen može ukloniti nečistoće poput klora, pesticida i hormona, kao i neugodne mirise i okuse.

■ Protok vode

Jedno je sigurno: nakon prolaska kroz različite slojeve, voda u vašoj čaši potpuno je bez nečistoća.

Dva filtera prikladna za sve uvjete

Napravljen po mjeri kako bi odgovarao kvaliteti vode gdje god se nalazili, Vital sustav filtracije dostupan je u dvije različite verzije: filter High Performance i verzija High Flow

*Samo filter High Performance

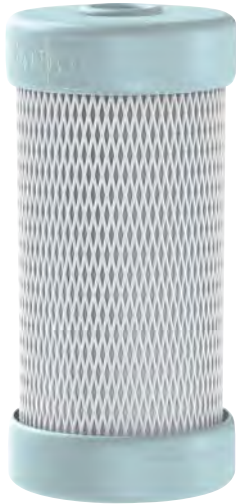

Filter High Performance

Kapsula filtera High Performance, koji osigurava do 500 litara vode izravno iz slavine, posebno je prikladna u situacijama kada kvaliteta vode uvijek ostaje unutar dolje navedenih granica. Ako su ove vrijednosti prekoračene, preporučljivo je odlučiti se za filter High Flow, koji predstavlja valjanu alternativu kada je potrebno povećati protok vode.

Predfilter

S mrežicom koja je 20 puta gušća od one uobičajenih filtera za vodu iz distribucijske mreže, vrlo je učinkovit u hvatanju hrđe, krhotina i sitnog taloga, za osjetno čišću vodu.

Aktivni ugljen

Aktivni ugljen smanjuje klor, okuse, mirise i mnoga druga onečišćenja. Ovaj visoko upijajući aktivni ugljen izrađen je od ljuski kokosovog oraha i ima čak manje pore od ostalih vrsta filtera s aktivnim ugljenom, za vodu koja je dobra za piće i bez okusa.

Standardne brzine protoka

Ovisno o raspoloživom tlaku vode, kapsula filtera High Performance nudi sljedeće početne brzine protoka.

PRITISAK	POČETNI PROTOK
1,0 bar	2,0 L/min
2,0 bara	3,0 L/min
3,0 bara	3,5 L/min

Pokazatelji kvalitete vode

Kapsula filtera High Performance posebno je prikladna u uvjetima kada kvaliteta vode uvijek ostaje unutar dolje navedenih granica.

INDIKATOR	VRIJEDNOST
Zamućenost ¹	< 1 NTU
TOC ²	< 2 mg/L

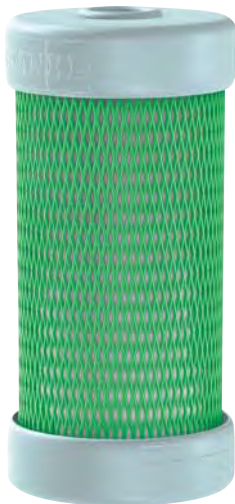

Filter High Flow

Kada je potrebno povećati brzinu protoka vode, kapsula filtera High Flow izvrsna je alternativa kapsuli High Performance. Napravljena s tijelom od aktivnog ugljena i opremljena kućištem predfiltera u čvrsto tkanoj mreži, kapsula filtera High Flow idealno je rješenje u situacijama kada se membrana kapsule High Performance prebrzo začepi zbog natprosječne razine sedimenta.

Standardne brzine protoka

Ovisno o raspoloživom tlaku vode, kapsula filtera High Flow nudi sljedeće početne brzine protoka.

PRITISAK	POČETNI PROTOK
0,5 bara	1,5 L/min
1,0 bar	2,5 L/min
1,5 bara	3,0 L/min
2,0 bara	3,5 L/min
3,0 bara	3,5 L/min

Pokazatelji kvalitete vode

Kapsula filtera High Flow posebno je prikladna u uvjetima kada kvaliteta vode uvijek ostaje unutar dolje navedenih granica.

INDIKATOR	VRIJEDNOST
Zamućenost ¹	< 5 NTU
TOC ²	< 2 mg/L

¹ Zamućenost se definira kao smanjenje prozornosti vode zbog prisutnosti čestica u vodi. Što je veći ukupan sadržaj čestica u vodi, to je veća razina zamućenja. Zamućenost se smatra valjanim parametrom za mjerenje kakvoće vode. Svjetska zdravstvena organizacija. (2017.). Smjernice za kvalitetu pitke vode, četvrto izdanje. Ukupni organski ugljik "Total organic carbon" (TOC) pokazatelj je razine biološke kontaminacije pitke vode.

Vital Semi-pro



VITAL SEMI-PRO

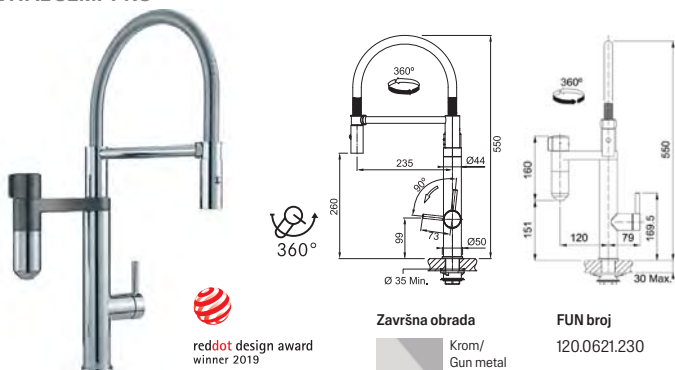

VITAL SEMI-PRO

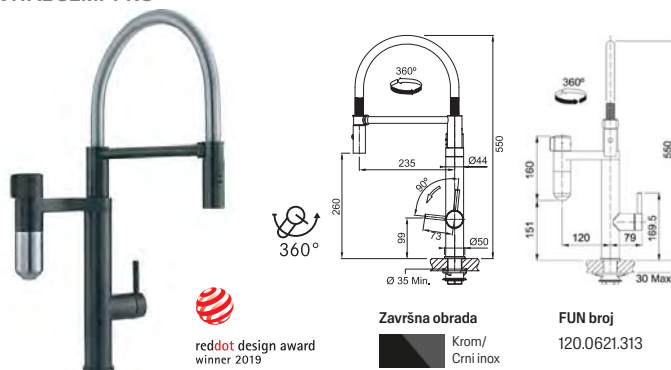

VITAL FILTER
HIGH PERFORMANCE 500 l - 1 kom



FUN broj
112.0607.497

VITAL FILTER
HIGH PERFORMANCE - Set 3 kom



FUN broj
112.0607.498

VITAL FILTER
HIGH FLOW 500 l - 1 kom



FUN broj
112.0606.784

VITAL FILTER
HIGH FLOW - Set 3 kom



FUN broj
112.0606.785



Slavine od nehrđa

Nehrđajući čelik



Atlas Neo Sensor
Doccia
str. 127



Pescara XL
Doccia
str. 128



Pescara L
Doccia
str. 128



Eos Neo
Doccia
str. 129



Eos Neo
str. 129



Kubus
Doccia
str. 129



Kubus
str. 129



Mythos
Doccia
str. 129



Mythos
str. 130



Atlas Neo
Doccia Eco
str. 130



Atlas Neo
Doccia
str. 130



Atlas Neo
str. 130



Atlas Neo
Doccia Window
str. 130



Atlas Neo
Window
str. 131



Tango Neo
Doccia Plus
str. 131



Tango Neo
Doccia
str. 131



Taros Neo
Doccia Plus
str. 131



Taros Neo
Doccia
str. 131



Taros Neo
str. 131

ajučeg čelika



Atlas Neo

Sensor





Kako biste saznali više,
skenirajte ove QR kodove.



Uporaba



Ugradnja

Prilikom pripreme hrane lako možete zaprljati ruke, ali zahvaljujući našoj slavini Atlas Neo Sensor nema potrebe dodirivati ju da biste otvorili vodu, što osigurava bolju higijenu i manje otisaka prstiju. Osim toga, ova moderna i visokotehnološka slavina štedi vodu i energiju, automatski prekidajući protok vode nakon 30 sekundi.

A ako se pitate odgovara li naša nevjerojatna slavina Atlas Neo Sensor stilu vaše kuhinje, budite uvjereni jer je dostupan u klasičnijoj verziji od nehrđajućeg čelika ili u ultramodernoj industrijskoj crnoj boji.

Praktično

Jednostavno stavite ruku blizu senzora slavine, bez potrebe da pritisnete gumb ili povlačite poluge, kako biste uživali u savršenom protoku vode u trajanju od 30 sekundi.



Čuvajte okoliš i svoj džep

Stavite lonac pod slavinu, otvorite je i zaboravite na nju; protok vode će prestati nakon pola minute, štedeći vodu i energiju.



Baš kako ti želiš

Postavite idealnu temperaturu prilikom ugradnje slavine, a ako želite topliju ili hladniju vodu samo je podesite polugom.

Higijenski

Kuhinja je jedna od najčešće korištenih prostora u domu i nikada ne možete biti previše oprezni kada je u pitanju higijena. Izbjegavanjem ručnog korištenja imat ćete manji rizik od kontaminacije ručke slavine virusima ili bakterijama.

Nepogrešiv stil

Zašto se odreći svog stila? Uskladite svoju slavinu s interijerom svoje kuhinje odabirom između ultramoderne industrijske crne ili klasičnog nehrđajućeg čelika.

Super ergonomski

Brza i jednostavna za instalaciju, naša Atlas Neo Sensor slavina je kompaktna, a upravljačka jedinica s baterijskim napajanjem zauzima vrlo malo prostora ispod sudopera.

ATLAS NEO SENSOR DOCCIA



NOVO

AISI 304

Ova slavina je izrađena od nehrđajućeg čelika AISI 304

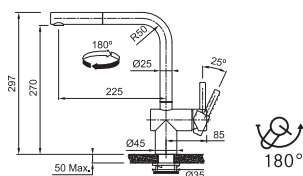

Završna obrada

Nehrdajući čelik

FUN broj

115.0625.523

ATLAS NEO SENSOR DOCCIA



NOVO

PVD

AISI 304

Ova slavina je izrađena od nehrđajućeg čelika AISI 304

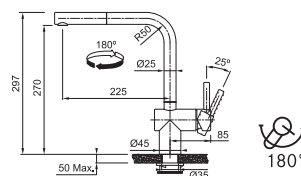

Završna obrada

Crni inox

FUN broj

115.0625.527

Slavine od nehrđajućeg čelika



reddot award 2017
winner



DESIGN
AWARD
2017

PESCARA XL DOCCIA



reddot award 2017
winner



DESIGN
AWARD
2017

AISI
304

Ova slavina je
izrađena od
nehrđajućeg
čelika AISI 304

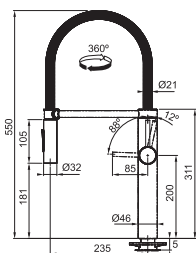

Završna obrada

Masivni
nehrđajući čelik

FUN broj

115.0472.959

PESCARA L DOCCIA



reddot award 2017
winner



DESIGN
AWARD
2017

AISI
304

Ova slavina je
izrađena od
nehrđajućeg
čelika AISI 304

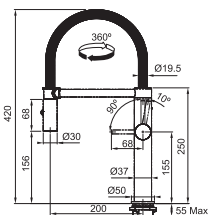

Završna obrada

Masivni
nehrđajući čelik

FUN broj

115.0472.960



EOS NEO DOCCIA



AISI 304

Ova slavina je izrađena od nehrđajućeg čelika AISI 304



Završna obrada

- Masivni nehrđajući čelik
- Crni masivni nehrđajući čelik

FUN broj
115.0590.045
115.0613.671

EOS NEO



AISI 304

Ova slavina je izrađena od nehrđajućeg čelika AISI 304

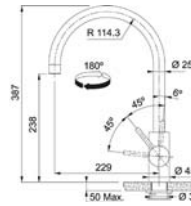

Završna obrada

- Masivni nehrđajući čelik
- Crni masivni nehrđajući čelik

FUN broj
115.0590.044
115.0613.590

KUBUS DOCCIA



AISI 304

Ova slavina je izrađena od nehrđajućeg čelika AISI 304

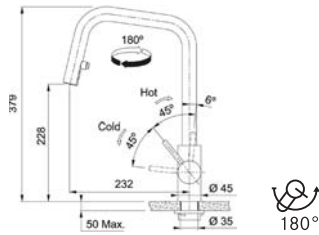

Završna obrada

- Masivni nehrđajući čelik

FUN broj
115.0529.207



KUBUS



AISI 304

Ova slavina je izrađena od nehrđajućeg čelika AISI 304

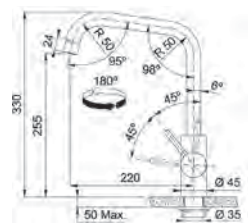

Završna obrada

- Masivni nehrđajući čelik

FUN broj
115.0529.202



MYTHOS DOCCIA



AISI 304

Ova slavina je izrađena od nehrđajućeg čelika AISI 304



Završna obrada

- Masivni nehrđajući čelik
- Crni masivni nehrđajući čelik

FUN broj
115.0547.853
115.0550.442

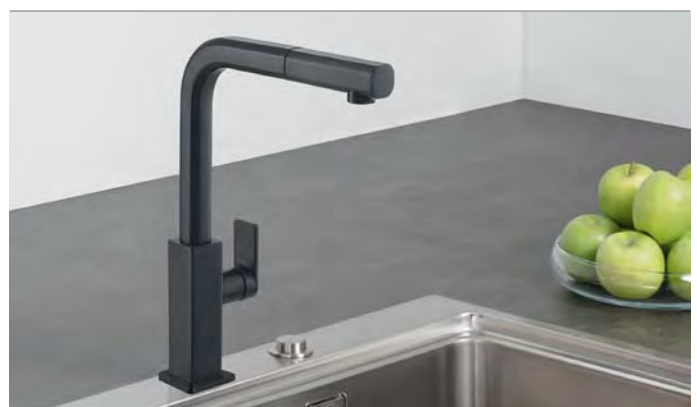



MYTHOS

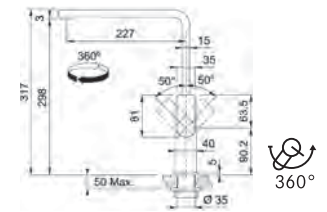

AISI 304

Ova slavina je izrađena od nehrđajućeg čelika AISI 304

Završna obrada

Masivni nehrđajući čelik

FUN broj

115.0547.852

ATLAS NEO DOCCIA ECO

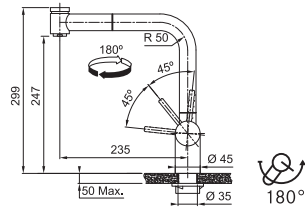

AISI 304

Ova slavina je izrađena od nehrđajućeg čelika AISI 304

Završna obrada

Masivni nehrđajući čelik

FUN broj

115.0521.441



ATLAS NEO DOCCIA

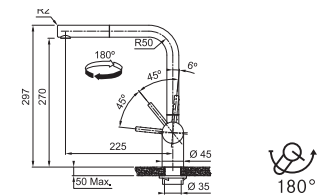

AISI 304

Ova slavina je izrađena od nehrđajućeg čelika AISI 304

Završna obrada

Masivni nehrđajući čelik
Crni masivni nehrđajući čelik

FUN broj

115.0521.438

115.0550.427

ATLAS NEO

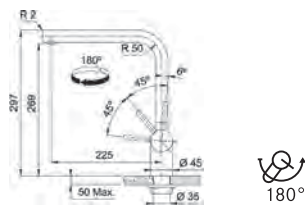

AISI 304

Ova slavina je izrađena od nehrđajućeg čelika AISI 304

Završna obrada

Masivni nehrđajući čelik

FUN broj

115.0521.435



ATLAS NEO DOCCIA WINDOW

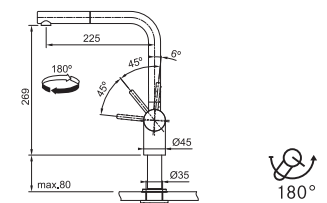

AISI 304

Ova slavina je izrađena od nehrđajućeg čelika AISI 304

Završna obrada

Masivni nehrđajući čelik

FUN broj

115.0521.439

ATLAS NEO WINDOW



AISI 304

Ova slavina je izrađena od nehrđajućeg čelika AISI 304

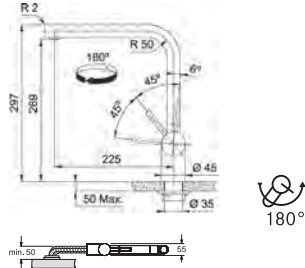

Završna obrada Masivni nehrđajući čelik
FUN broj 115.0521.436



TANGO NEO DOCCIA PLUS



AISI 304

Ova slavina je izrađena od nehrđajućeg čelika AISI 304

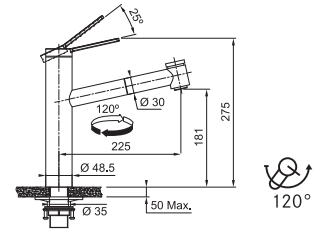

Završna obrada Masivni nehrđajući čelik
FUN broj 115.0596.389

TANGO NEO DOCCIA



AISI 304

Ova slavina je izrađena od nehrđajućeg čelika AISI 304

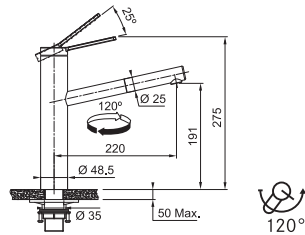

Završna obrada Masivni nehrđajući čelik
FUN broj 115.0596.388



TAROS NEO DOCCIA PLUS



AISI 304

Ova slavina je izrađena od nehrđajućeg čelika AISI 304

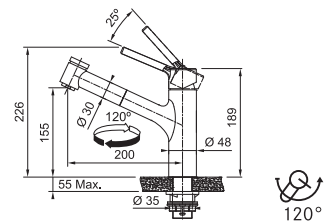

Završna obrada Masivni nehrđajući čelik
FUN broj 115.0596.386

TAROS NEO DOCCIA



AISI 304

Ova slavina je izrađena od nehrđajućeg čelika AISI 304

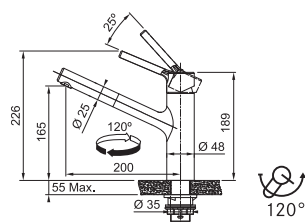

Završna obrada Masivni nehrđajući čelik
FUN broj 115.0596.383

TAROS NEO



AISI 304

Ova slavina je izrađena od nehrđajućeg čelika AISI 304

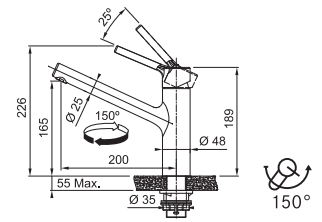

Završna obrada Masivni nehrđajući čelik
FUN broj 115.0596.320

Slavine



reddot winner 2021



Nehrđajući čelik optik



Active Twist
Doccia
str. 136

Krom



Icon
Doccia
str. 138



Fox Pro
Doccia
str. 138



Joy Cocktail
str. 138



Lina Semi-Pro
str. 139



Active J
Doccia
str. 139



Active J
str. 139



Maris
Doccia
str. 139



Maris
str. 139



Active L
Doccia
str. 139



Active L
str. 139



Neptune Evo
Doccia
str. 140



Neptune Evo
str. 140



Neptune Style
Window
str. 140



Sirius L
Doccia
str. 140



Lina L
str. 140



Centro
Doccia Plus
str. 140



Centro
Doccia
str. 140



Centro
str. 140



Centro
Doccia Window
str. 141



Orbit
Doccia
str. 141



Orbit
str. 141



Lina J
Doccia
str. 141



Lina XL J
str. 141



Fox
str. 141



Novara Plus
Doccia
str. 141



Novara
Plus
str. 141



Basic
str. 141

Crna mat



Icon Semi-Pro
str. 142



Icon
Doccia
str. 142



Active L
Doccia
str. 143



Active L
str. 143



Urban
Doccia
str. 143



Urban
str. 143



Lina
Doccia
str. 143



Lina XL
str. 143



Novara Plus
Doccia
str. 143



Novara Plus
str. 143

Krom-fragranit



Sirius L
Doccia
str. 144



Orbit
Doccia
str. 144



Orbit
str. 144

Fragranit



Active Plus L
Doccia
str. 145



Active Plus L
str. 145



Urban
Doccia
str. 145



Urban
str. 145



Lina
Doccia
str. 145



Lina XL
str. 146



Novara Plus
Doccia
str. 146



Novara Plus
str. 146

Rustikalne



Old England
str. 146

Niskotlačne



Novara Plus
str. 147



Novara Plus
str. 147

Active

Twist



Za više
informacija
skenirajte
QR kod

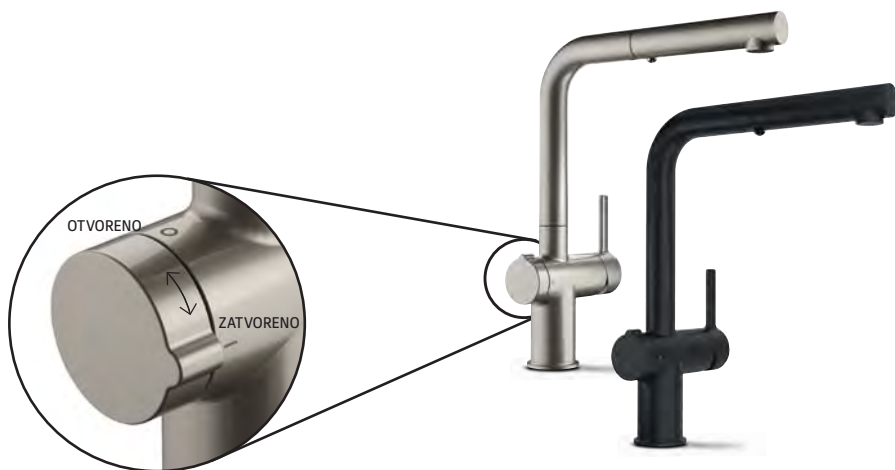

S Active Twistom stvorili smo slavinu koja radi drugačije, sposobnu ne samo napuniti vaš sudoper već ga i isprazniti. Osim elegantnog i minimalističkog dizajna, integrirali smo ekskluzivnu i inovativnu funkciju koja spaja slavinu i sudoper s posebnim uređajem koji, kada se uključi, aktivira odvod omogućavajući da voda istječe na jednostavan, siguran i higijenski način bez potrebe za stavljanjem ruku u vruću i prljavu vodu.

Značajke i prednosti

Inovativna integrirana kontrola odvoda sudopera

Dizajn all-in-one uključuje poseban uređaj koji, kada se uključi, aktivira odvod omogućavajući lako, sigurno i higijenski otjecanje vode bez potrebe za stavljanjem ruku u sudoper.

Eco uložak

Dizajniran kako bi ograničio protok i regulirao temperaturu, ECO uložak vam pomaže aktivno štedjeti vodu i energiju. Zahvaljujući ručici s dva položaja otvaranja moguće je smanjiti potrošnju vode do 50%.

Funkcija prskanja

Zahvaljujući snažnom protoku vode, funkcija prskanja olakšava ispiranje voća i povrća, uklanjajući i najtvrdokorniju prljavštinu s posuđa. Također pokriva široko područje pranja dopirući do svakog kuta sudopera, čineći čišćenje mnogo lakšim.

Laminarni aeratori

Laminarni aerator ugrađen u glavu slavine osigurava da Active Twist nudi kristalno čistu vodu, bez prskanja, bez stvaranja buke.

Lakoća čišćenja

Zahvaljujući fluidnom, zaobljenom dizajnu i zaobljenim rubovima, čišćenje slavine Active Twist vrlo je jednostavno.

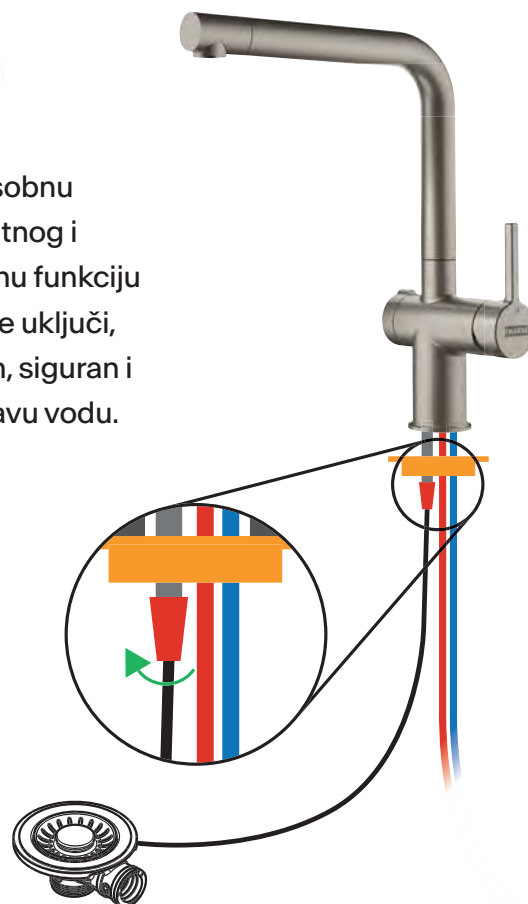

Active Twist



ACTIVE TWIST DOCCIA

ACTIVE TWIST DOCCIA

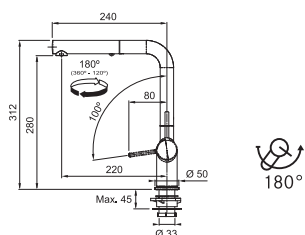

Završna obrada **FUN broj**
 Nehrđajući čelik **115.0653.505**
 optik

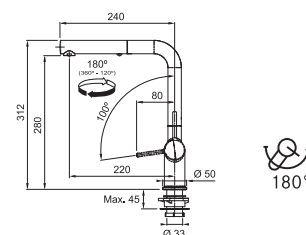

Završna obrada **FUN broj**
 Crna mat **115.0669.769**

Odaberite kombinaciju

Koji je najbolji način da imate lijep i funkcionalan prostor za pranje? Uparite Active Twist s našim sudoperima od nehrđajućeg čelika i fragranita! U nastavku provjerite na koje se modele može instalirati.



Box Center
Serija: BXX



Mythos
Serija: MYX



Maris
Serija: MRX



Kubus 2
Serija: KNG



Vasche Maris
Serija: MRG



Lavelli Maris
Serija: MRG



Urban
Serija: UBG



Boston
Serija: BFG

Odvodni set za ugradnju

Uskladite željeni model sudopera sa slavnom Active Twist i saznajte koji odvodni pribor morate kupiti za ispravnu montažu.

Za kombinaciju Total Black Matt dostupno je sljedeće za naručivanje: set za odvod, preljev i poklopac za odvod, ovisno o modelu.



Serija	Materijal	Kompatibilni modeli	Doccia 115.0653.505	Doccia 115.0669.769
Sudoperi Box Center	Nehrđajući čelik	Svi modeli	112.0301.698	
Korita Mythos	Nehrđajući čelik	Svi modeli	112.0301.698	
Korita Maris	Nehrđajući čelik	Svi modeli	112.0301.698	
Korita Kubus 2	Fragranit	Svi modeli KNG 110	112.0389.090	112.0389.090 133.0668.855 112.0670.893
		Svi modeli KNG 120	112.0389.090	112.0389.090 133.0668.855 2 x 112.0670.893
Korita Maris	Fragranit	Svi modeli MRG 110 i 610	112.0544.161	112.0656.939 133.0668.855 112.0657.146
		Svi modeli MRG 120 i 620	112.0544.161	112.0656.939 112.0668.276 133.0668.855 112.0657.146
Sudoperi Maris	Fragranit	Svi modeli	112.0544.161	
		Svi modeli MRG 611 (ne 621)		112.0656.939 133.0668.854
		Svi modeli MRG 651 (ne 621)		112.0656.939 112.0668.276 133.0668.854
Sudoperi i korita Urban	Fragranit	Svi modeli UBG 610 / 611	112.0544.161	112.0656.939 133.0668.854
		Svi modeli UBG 620 / 621	112.0544.161	112.0656.939 112.0668.276 133.0668.854
Sudoperi Boston	Fragranit	Svi modeli BFG 611	112.0544.161	112.0656.939 133.0668.854
		Svi modeli BFG 621 / 651	112.0544.161	112.0656.939 112.0668.276 133.0668.854

Krom



reddot winner 2021

Savršeno za one koji traže bezvremenski proizvod, s jedinstvenim stilom koji kombinira dizajn i funkcionalnost.



ICON DOCCIA

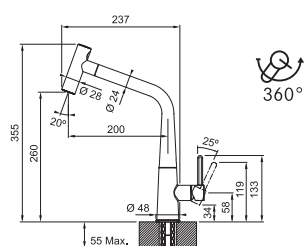

Završna obrada
Krom

FUN broj
115.0625.188

FOX PRO DOCCIA

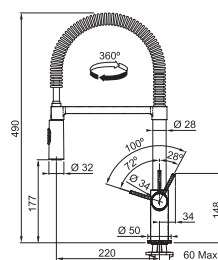

Završna obrada
Krom

FUN broj
115.0486.993



JOY COCKTAIL

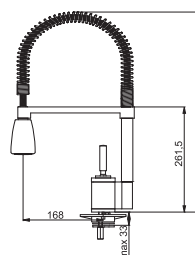

Završna obrada
Krom

FUN broj
115.0029.591

LINA SEMI-PRO

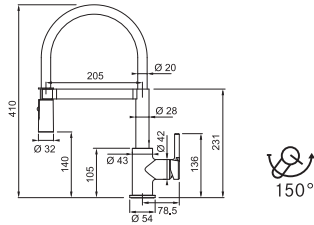

Završna obrada	FUN broj
Krom/crna	115.0626.085
Krom/siva	115.0626.087
Krom/bijela	115.0626.088

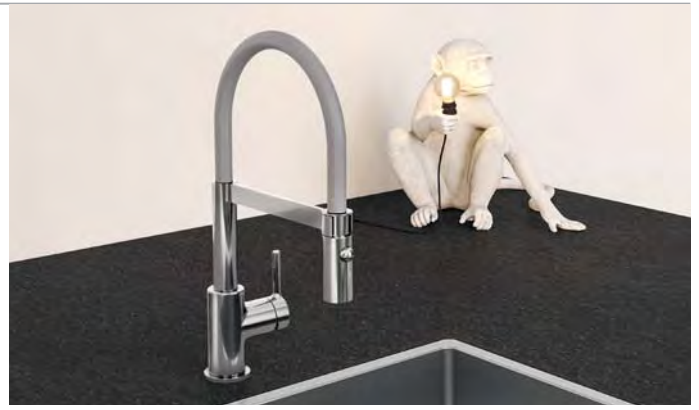

ACTIVE J DOCCIA



Završna obrada	FUN broj
Krom	115.0653.401

ACTIVE J

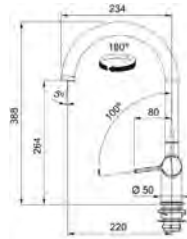

Završna obrada	FUN broj
Krom	115.0653.395

MARIS DOCCIA



reddot award 2017 winner

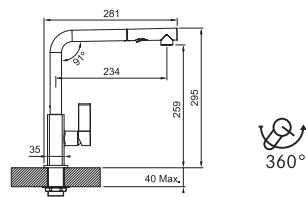

Završna obrada	FUN broj
Krom	115.0392.357

MARIS

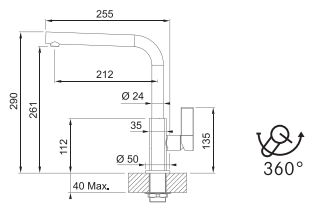

Završna obrada	FUN broj
Krom	115.0392.332

ACTIVE L DOCCIA

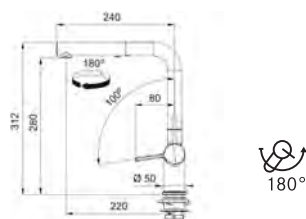

Završna obrada	FUN broj
Krom	115.0653.379

ACTIVE L

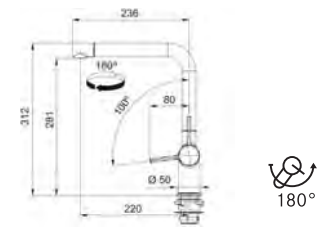

Završna obrada	FUN broj
Krom	115.0653.298

NEPTUNE EVO DOCCIA

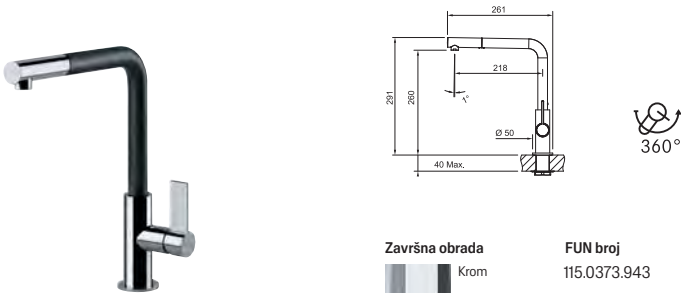

Završna obrada: Krom
FUN broj: 115.0373.943

NEPTUNE EVO

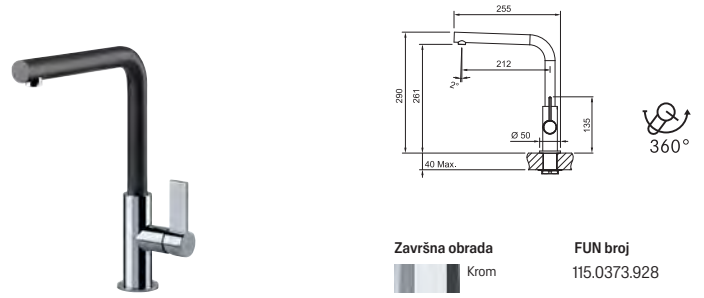

Završna obrada: Krom
FUN broj: 115.0373.928



SIRIUS L DOCCIA

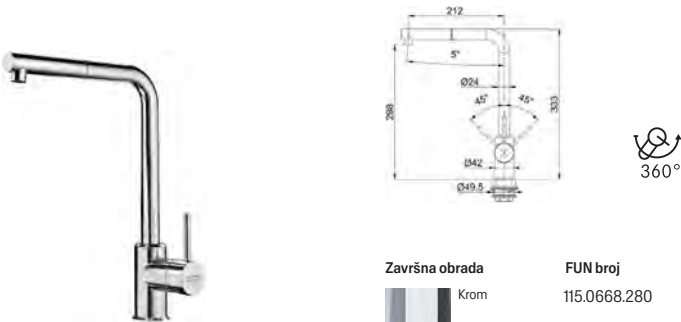

Završna obrada: Krom
FUN broj: 115.0668.280

NEPTUNE STYLE WINDOW

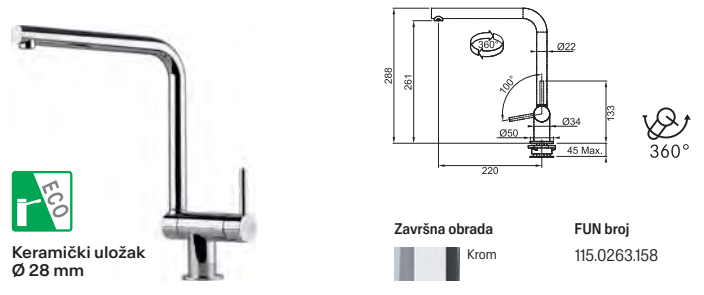

Keramički uložak Ø 28 mm

Završna obrada: Krom
FUN broj: 115.0263.158

LINA L

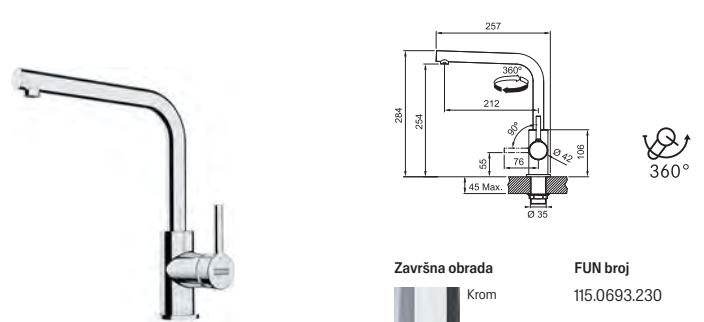

Završna obrada: Krom
FUN broj: 115.0693.230

CENTRO DOCCIA PLUS

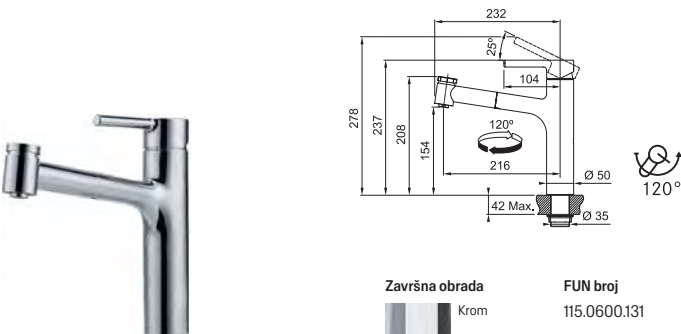

Završna obrada: Krom
FUN broj: 115.0600.131

CENTRO DOCCIA

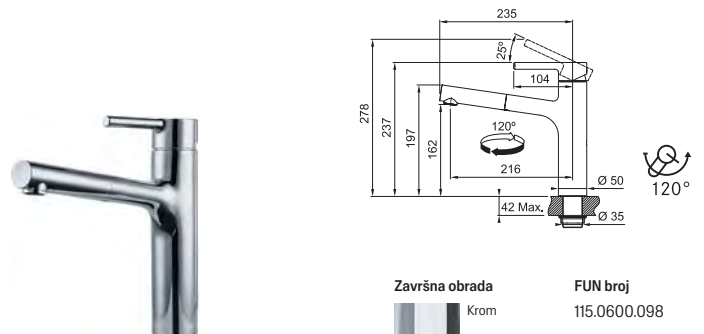

Završna obrada: Krom
FUN broj: 115.0600.098

CENTRO

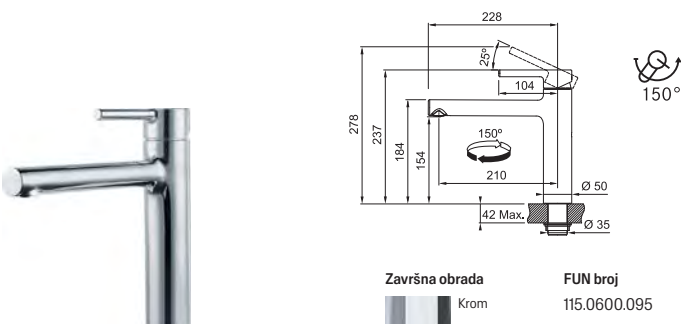

Završna obrada: Krom
FUN broj: 115.0600.095





CENTRO DOCCIA WINDOW

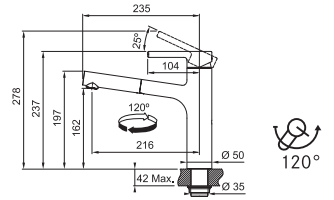

Završna obrada
Krom

FUN broj
115.0600.138

ORBIT DOCCIA

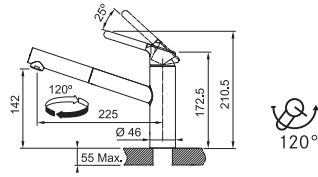

Završna obrada
Krom

FUN broj
115.0623.055

ORBIT

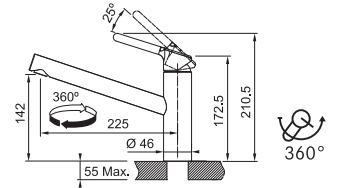

Završna obrada
Krom

FUN broj
115.0623.054

LINA J DOCCIA

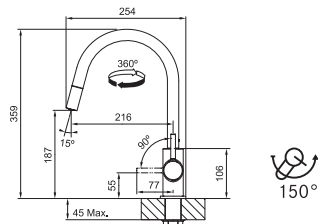

Završna obrada
Krom

FUN broj
115.0693.229

LINA XL J

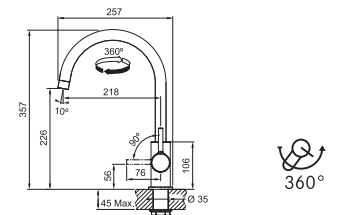

Završna obrada
Krom

FUN broj
115.0693.228

FOX

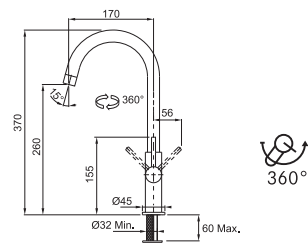

Završna obrada
Krom

FUN broj
115.0250.143

NOVARA PLUS DOCCIA

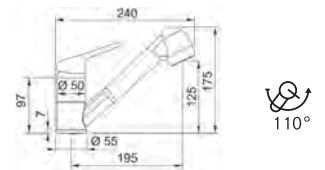

Završna obrada
Krom

FUN broj
115.0347.111

NOVARA PLUS

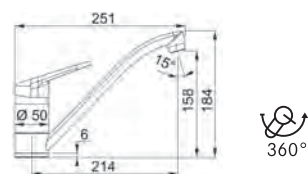

Završna obrada
Krom

FUN broj
115.0347.142

BASIC

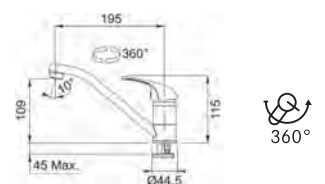

Završna obrada
Krom

FUN broj
115.0707.619

Crna mat



reddot winner 2023

ICON SEMI PRO



NOVO



reddot winner 2023

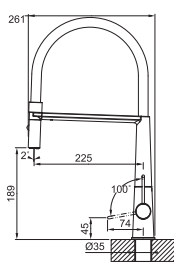

360°

Završna obrada



Crna mat

FUN broj

115.0690.598



reddot winner 2021

ICON DOCCIA



reddot winner 2021

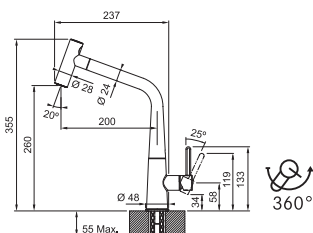

360°

Završna obrada



Crna mat

FUN broj

115.0625.190

ACTIVE L DOCCIA

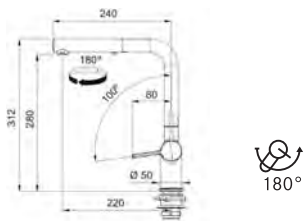

Završna obrada: Crna mat
 FUN broj: 115.0653.382

ACTIVE L

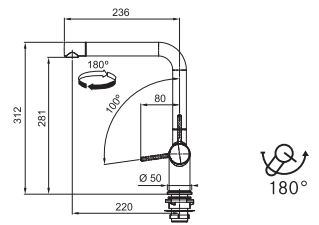

Završna obrada: Crna mat
 FUN broj: 115.0653.371

URBAN DOCCIA

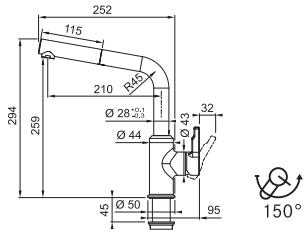

Završna obrada: Crna mat
 FUN broj: 115.0627.523

URBAN

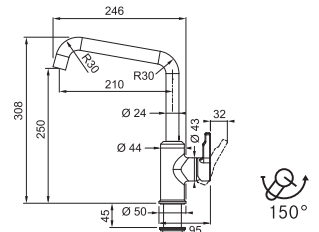

Završna obrada: Crna mat
 FUN broj: 115.0627.524

LINA DOCCIA

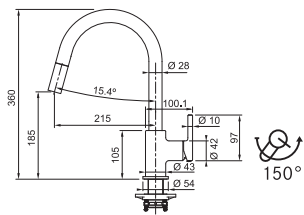

Završna obrada: Crna mat
 FUN broj: 115.0626.053

LINA XL

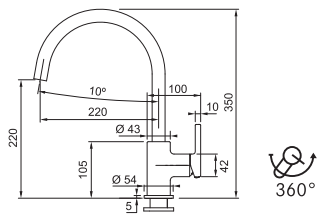

Završna obrada: Crna mat
 FUN broj: 115.0626.019

NOVARA PLUS DOCCIA



Završna obrada: Crna mat
 FUN broj: 115.0659.840

NOVARA PLUS



Završna obrada: Crna mat
 FUN broj: 115.0659.961

Krom-fragranit



SIRIUS L DOCCIA

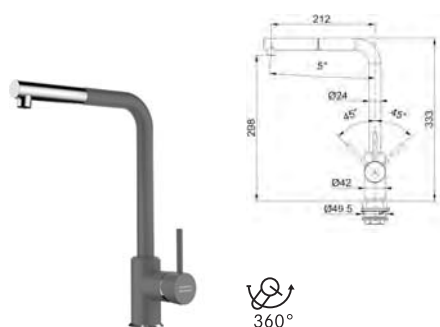

Završna obrada / FUN broj

- 115.0668.279 Krom/Crna
- 115.0668.381 Krom/Kameno siva
- 115.0668.382 Krom/Glečer bijela
- 115.0668.383 Krom/Avena

ORBIT DOCCIA

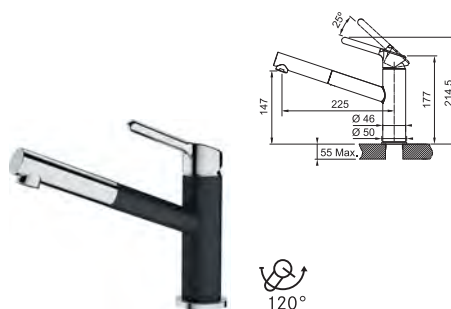

Završna obrada / FUN broj

- 115.0623.057 Krom/Crna
- 115.0623.141 Krom/Kameno siva
- 115.0623.139 Krom/Glečer bijela
- 115.0623.059 Krom/Sahara
- 115.0623.136 Krom/Avena
- 115.0623.147 Krom/Kašmir

ORBIT

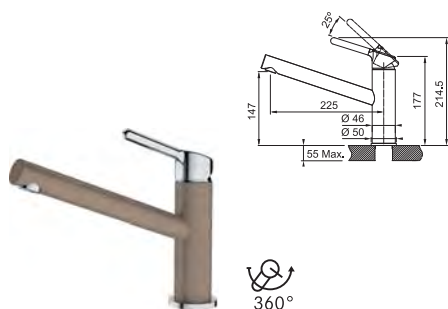

Završna obrada / FUN broj

- 115.0623.056 Krom/Crna
- 115.0623.140 Krom/Kameno siva
- 115.0623.137 Krom/Glečer bijela
- 115.0623.135 Krom/Avena
- 115.0623.146 Krom/Kašmir

Fragranit



ACTIVE PLUS L DOCCIA

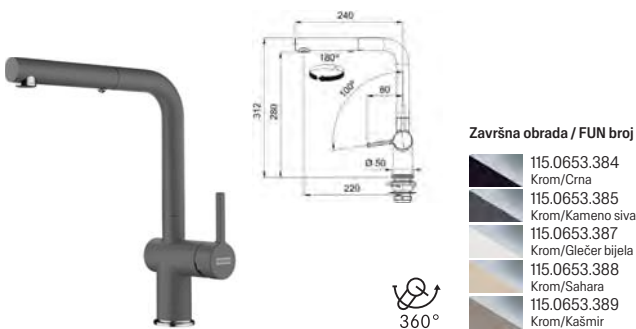

ACTIVE PLUS L



URBAN DOCCIA

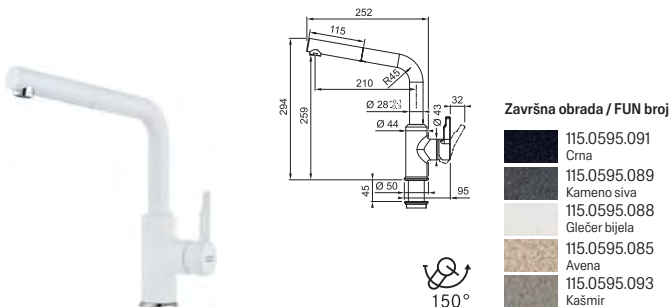

URBAN

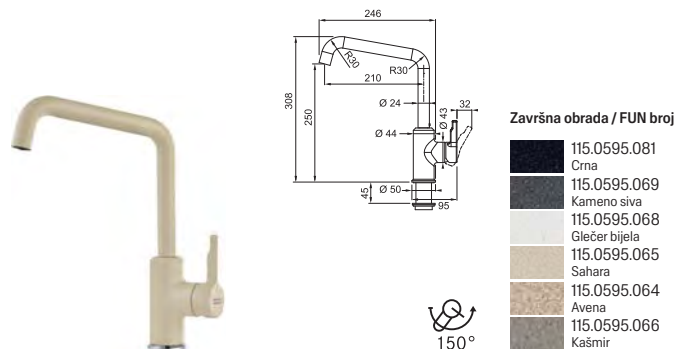

LINA DOCCIA

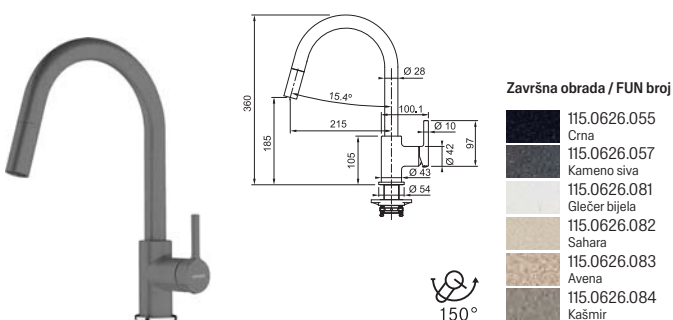



NOVARA PLUS DOCCIA

LINA XL

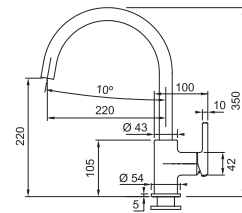

Završna obrada / FUN broj

- 115.0626.020 Crna
- 115.0626.022 Kameno siva
- 115.0626.024 Glečer bijela
- 115.0626.025 Sahara
- 115.0626.026 Avena
- 115.0626.028 Kašmir



NOVARA PLUS

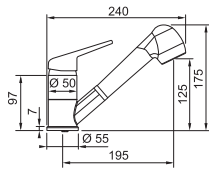

Završna obrada / FUN broj

- 115.0470.675 Crna
- 115.0470.670 Kameno siva
- 115.0470.669 Glečer bijela
- 115.0470.663 Sahara
- 115.0470.665 Avena
- 115.0470.666 Kašmir

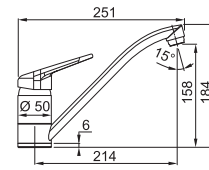

Završna obrada / FUN broj

- 115.0470.661 Crna
- 115.0470.659 Kameno siva
- 115.0470.658 Glečer bijela
- 115.0470.653 Sahara
- 115.0470.654 Avena
- 115.0470.655 Kašmir



Rustikalne



OLD ENGLAND

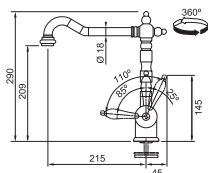

Završna obrada / FUN broj

- 115.0060.360 Krom
- 115.0028.205 Boja bronca
- 115.0028.208 Bakar



Niskotlačne



NOVARA PLUS niskotlačna

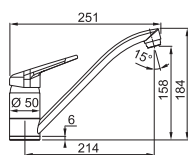

360°



Završna obrada
Krom

FUN broj
115.0512.912

NOVARA PLUS niskotlačna

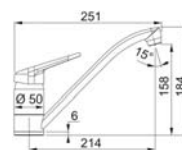

120°



Završna obrada
Crna mat

FUN broj
115.0659.963

Dodatni pribor



slavine

Dodaci

PODUPIRAČI SLAVINE

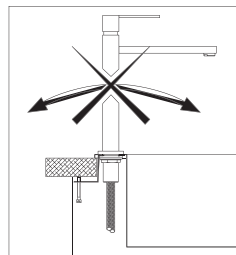

Model	FUN broj
Podupirač slavine/ 1 komad	112.0187.655
Podupirač slavine/ 1 komad - uz seriju Planar	112.0189.800

PODUPIRAČI SLAVINE



- čvrsto prisanjanje podupirača zahvaljujući stabilnom spoju na radnu ploču
- za sudopere s rupom od 35 mm
- pričvršćivanje ljepljivom ili vijcima
- preporuča se za visoke i teške slavine

Model	FUN broj
Podupirač slavine	133.0026.896

PAR FILTERA



Napomena: Filteri za slavine s fleksibilnim dovodnim cijevima. Sprječavaju oštećivanje uloška slavine.

Model	FUN broj
Par filtera za slavinu	112.0158.403

Sredstvo za čišćenje

SREDSTVO ZA ČIŠĆENJE SLAVINA



Proizvod	FUN broj
Sredstvo za čišćenje slavina - 250 ml	112.0530.239

Sorteri

Sorteri otpada



Sorter FX
FX 60-26-26
str. 152



Sorter FX
FX 60-26-11-11
str. 152



Sorter Garbo
Garbo 60-4
str. 152



Sorter Garbo
Garbo 60-3
str. 153



Sorter Garbo
Garbo 60-2
str. 153



Sorter Garbo
Garbo 50-3
str. 153



Sorter Cube
Cube 50
str. 153



Sorter Garbo
Garbo 45-2
str. 153



Sorter Cube
Cube 40
str. 153



Sorter Cube
Cube 30
str. 153



Sorter Pivot
Pivot
str. 154



Sorter Mini
Mini
str. 154



Sorter Cube
Cube kutni
str. 154



Sorter Easysort
Easysort 600-3-0
str. 154



Sorter Easysort
Easysort 600-2-2
str. 154



Sorter Easysort
Easysort 450-2-0
str. 154



Sorter Easysort
Easysort 450-1-2
str. 154



otpada



Fx/Garbo/Cube/ Pivot/Mini/Easysort



FX 60-26-26

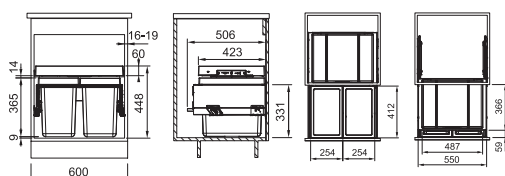

FUN broj
121.0557.764

Ormar	600 mm
Ugradb.dimenzije Š x D x V	600 x 506 x 448 mm
Maks. ugrad. širina	-
Spremnici	2x26l

FX 60-26-11-11

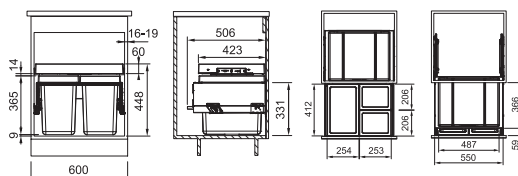

FUN broj
121.0557.763

Ormar	600 mm
Ugradb.dimenzije Š x D x V	600 x 506 x 448 mm
Maks. ugrad. širina	-
Spremnici	1x26l + 11l + 11l

GARBO 60-4

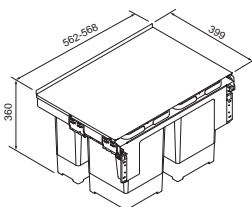

8l	8l
12l	12l

FUN broj
121.0200.676

Ormar	600 mm
Ugradb.dimenzije Š x D x V	562 x 399 x 360 mm
Maks. ugrad. širina	568 mm
Spremnici	2x8l + 2x12l

GARBO 60-3

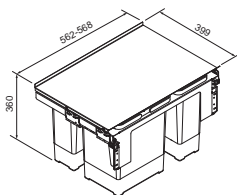

12l	Sammelochale
18l	8l

FUN broj
121.0200.680

Ormar	600 mm
Ugradb.dimenzije Š x D x V	562 x 399 x 360 mm
Maks. ugrad. širina	568 mm
Spremnici	18l + 12l + 8l + pr.

GARBO 60-2

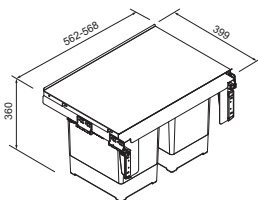

18l	18l
-----	-----

FUN broj
121.0284.027

Ormar	600 mm
Ugradb.dimenzije Š x D x V	562 x 399 x 360 mm
Maks. ugrad. širina	568 mm
Spremnici	18l + 18l

GARBO 50-3

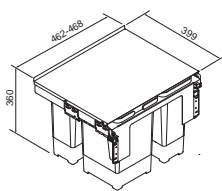

8l	
12l	12l

FUN broj
121.0200.691

Ormar	500 mm
Ugradb.dimenzije Š x D x V	462 x 399 x 360 mm
Maks. ugrad. širina	468 mm
Spremnici	8l + 2x12l

CUBE 50

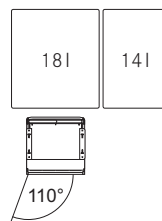
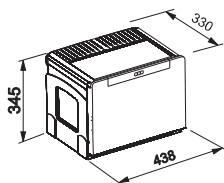

FUN broj
134.0055.289

Ormar	500 mm
Ugradb.dimenzije Š x D x V	470 x 330 x 345 mm
Spremnici	18l + 14l

GARBO 45-2

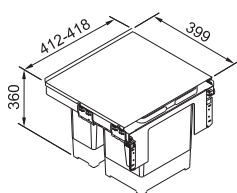

12l	
18l	

FUN broj
121.0200.692

Ormar	450 mm
Ugradb.dimenzije Š x D x V	412 x 399 x 360 mm
Maks. ugrad. širina	418 mm
Spremnici	18l + 12l

CUBE 40

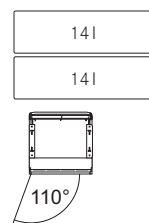
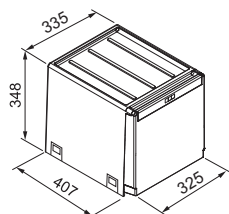

FUN broj
134.0039.330

Ormar	400 mm
Ugradb.dimenzije Š x D x V	335 x 407 x 348 mm
Spremnici	14l + 14l

CUBE 30

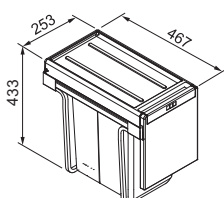

15l	
15l	

FUN broj
134.0039.553

Ormar	600 mm
Dimenzije Š x D x V	253 x 467 x 433 mm
Spremnici	15l + 15l

PIVOT

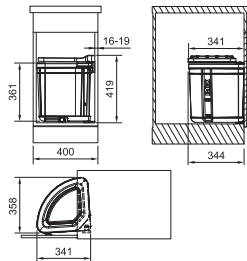

FUN broj
121.0307.563

Ormar | 400 mm
Dimenzije Š x D x V | 344 x 358 x 419 mm
Spremnici | 35 l

MINI

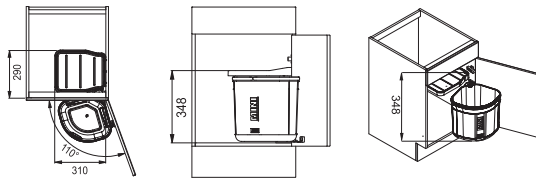

FUN broj
121.0176.518

Ormar | 400 mm
Dimenzije Š x D x V | 310 x 310 x 348 mm
Spremnici | 17,5 l

CUBE KUTNI

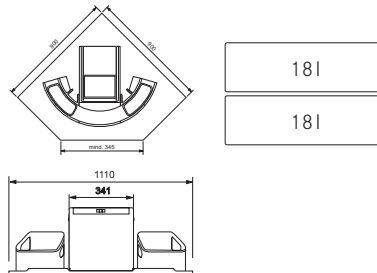

FUN broj
134.0055.286

Ormar | 900 x 900 mm
Dimenzije Š x D x V | 345 x 700 x 335 mm
Spremnici | 18 l + 18 l

EASYSORT 600-3-0

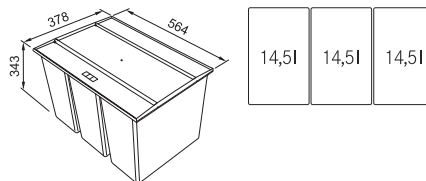

FUN broj
121.0494.192

Ormar | 600 mm
Ugradb.dimenzije Š x D x V | 564 x 378 x 343 mm
Maks. ugrad. širina | -
Spremnici | 3 x 14,5 l

EASYSORT 600-2-2

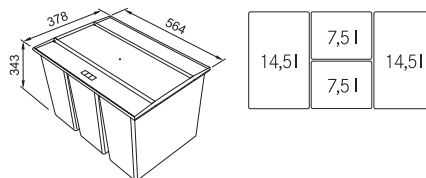

FUN broj
121.0494.193

Ormar | 600 mm
Ugradb.dimenzije Š x D x V | 564 x 378 x 343 mm
Maks. ugrad. širina | -
Spremnici | 2 x 14,5 l + 2 x 7,5 l

EASYSORT 450-2-0

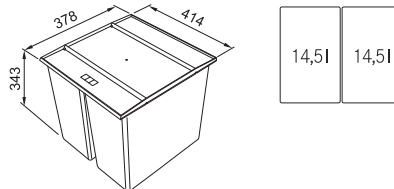

FUN broj
121.0494.182

Ormar | 450 mm
Ugradb.dimenzije Š x D x V | 414 x 378 x 343 mm
Maks. ugrad. širina | -
Spremnici | 2 x 14,5 l

EASYSORT 450-1-2

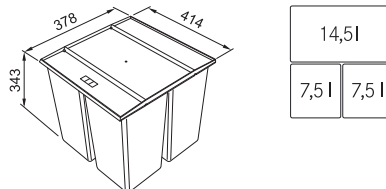



FUN broj
121.0494.150

Ormar | 450 mm
Ugradb.dimenzije Š x D x V | 414 x 378 x 343 mm
Maks. ugrad. širina | -
Spremnici | 14,5 l + 2 x 7,5 l

Odvodni elementi

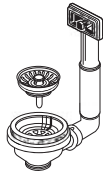
Pribor za sudopere s pojednostavljenom ambalažom

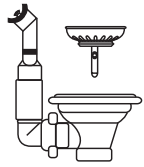
	BKT 3" 1/2 sa T.P.	BKT 3" 1/2 sa T.P.+ BKT 3" 1/2	BKT 3" 1/2 sa T.P.
FUN kod	112.0059.982	112.0059.989	112.0158.384
			
Model sudopera			
AM.. 120 - 160	•		
LL.. 611		•	
LL.. 620 - 621		•	
LL.. 651		•	
SK 611	•		
SK 620-651		•	
SRX 611			
SRX 620 - 651 - 621			

Sifoni

Pribor za sudopere s pojednostavljenom ambalažom

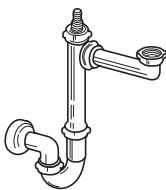
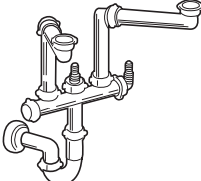
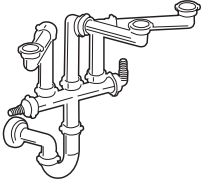
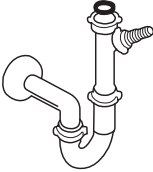
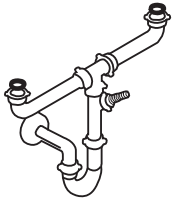
	F/1279 TIP ZA UŠTEDU PROSTORA	F/1275 TIP ZA UŠTEDU PROSTORA	F/1273 TIP ZA UŠTEDU PROSTORA	F/1 L	F/2 L
FUN kod	112.0048.206	112.0048.209	112.0048.210	112.0068.243	112.0068.244
					
Model sudopera					
1 korito	•			•	
2 korita jednake dubine		•			•
2 korita različitih dubina		•			

Spojni elementi

Pribor za sudopere s pojednostavljenom ambalažom

FUN			112.0068.252	112.0059.999	112.0068.253	133.0048.423	112.0073.250	112.0064.407	133.0176.050
			4 kopče i podložna pločica	6 kopči	6 kopči i podložna pločica	8 kopči	8 kopči i podložna pločica	12 kopči i podložna pločica	10 kopči
611	790x500	LLX			•				
	860x500	LLX			•				
	860x500	SRX							•
620	860x500	SRX							•
	860x500	SKX		•					
651	1000x500	LLX					•		
	1000x500	SRX							•
621	1160x500	LLX					•		
	1160x500	SRX							•

Načini ugradnje sudopera

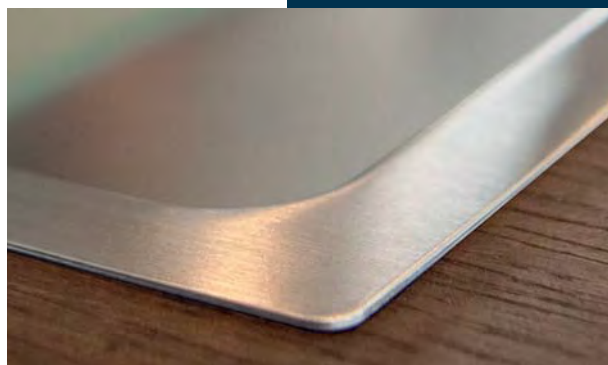

Načini ugradnje sudopera: razlike u rubu sudopera



RUB
SLIM TOP

Poluporavnana standardna ugradnja - moderno rješenje

Novi način ugradnje na čvrste ili laminirane radne ploče. Izuzetno laka ugradnja i iznimna elegancija.

Rub slim top je debljine 1 mm.

Prikladan materijal: nehrđajući čelik

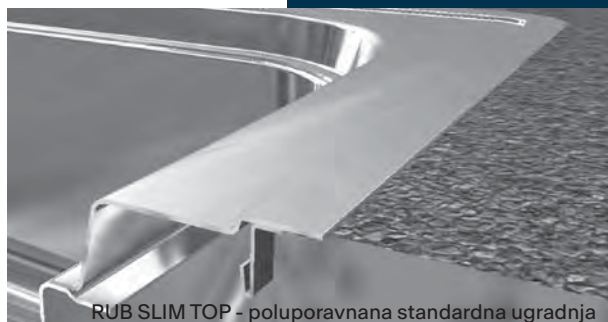

RUB
SLIM TOP

Poravnana ugradnja - purističko rješenje

Način ugradnje urezivanjem radne ploče za debljinu ruba sudopera, tako da su sudoper i radna ploča, u konačnici, potpuno u ravnini.

Rub slim top je debljine 1 mm.

Prikladni materijali: nehrđajući čelik, FrAGRANIT+ i FrACERAM keramika

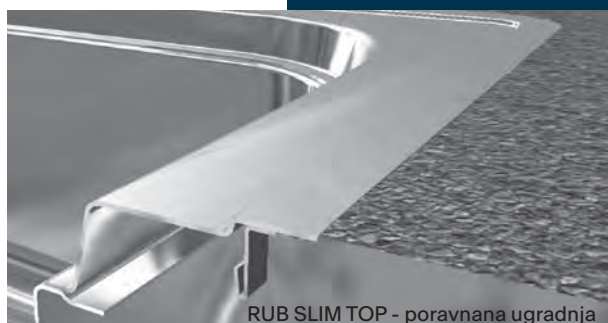

Ugradnja pod radnu ploču - elegantno rješenje

Ugradnja sudopera pod radnu ploču povećava iskoristivu radnu površinu i bitno olakšava rad u kuhinji, kao i njeno čišćenje.

Prikladni materijali: nehrđajući čelik, FrAGRANIT+ i FrACERAM keramika



RUB
STANDARD



RUB
SLIM

Standardna ugradnja - klasično rješenje

Kod standardne ugradnje, rub je izbočen. Izbočeni rub daje sudoperu dodatnu stabilnost.

Sudoper je fiksiran u otvoru radne ploče, koja može biti izrađena od bilo kojeg materijala. Ovakav izgled sudopera izuzetno odgovara dizajnu kuhinja u klasičnom stilu.

Rub standard je debljine 6 mm, a rub slim je debljine 4 mm što mu daje veću eleganciju.

Prikladni materijali: nehrđajući čelik, FrAGRANIT+ i FrACERAM keramika



Simboli

Simboli vam omogućuju brz pregled tehničkih karakteristika sudopera:



TVORNIČKI UGRAĐENA BRTVA

Optimalan estetski učinak i maksimalna jednostavnost ugradnje.



MEHANIČKI POVLAČNI DALJINSKI OTVARAČ PILETE

Omogućuje pražnjenje vode iz sudopera bez močenja ruku. Upravljačka ručica nalazi se pored slavine.



MEHANIČKI ZAKRETNI DALJINSKI OTVARAČ PILETE

Omogućuje pražnjenje vode iz sudopera bez močenja ruku. Upravljačka ručica nalazi se pored slavine.



"PUSH-PULL" DALJINSKI OTVARAČ PILETE

Omogućuje pražnjenje vode iz sudopera bez močenja ruku. Upravljačka ručica nalazi se pored slavine.



DODATNI PRIBOR KOJI JE UKLJUČEN UZ SUDOPER

Velika ponuda raznih dodataka na nekim modelima omogućava da se korito sudopera maksimalno iskoristi (kao cjedilo, prostor za rezanje i pripremanje namirnica itd.).



TIS

Podupirač slavine



MEHANIČKI POVLAČNI DALJINSKI OTVARAČ PILETE

Omogućuje pražnjenje vode iz sudopera bez močenja ruku. Upravljačka ručica nalazi se pored slavine.



MEHANIČKI ZAKRETNI DALJINSKI OTVARAČ PILETE

Omogućuje pražnjenje vode iz sudopera bez močenja ruku. Upravljačka ručica nalazi se pored slavine.



DOZATOR TEKUĆEG DETERDŽENTA

Vrlo koristan dodatak koji omogućuje da je deterdžent uvijek nadohvat ruke te optimizira pranje. Prije kupnje provjeriti mogućnost ugradnje na sudoper.



DROBILICA ZA OTPAD

Zahvaljujući ovom korisnom uređaju, gospodarenje organskim otpadom postaje vrlo jednostavno.



INTEGRIRANI ODVOD

Odvod sudopera ne montira se naknadno, nego je utisnut na samom sudoperu. Tako su izbjegnuti spojevi i procjepi u kojima se nakupljaju nečistoće.



RUB STANDARD



RUB SLIM



RUB SLIM TOP (SEMIFILO)



RUB SLIM TOP



UGRADNJA POD RADNU PLOČU



SUDOPER S OCJEĐIVAČEM DESNO



SUDOPER S OCJEĐIVAČEM LIJEVO



REVERZIBILNI SUDOPER



BOSNIA & HERZEGOVINA / Gemma BH d.o.o.

7 1000 Sarajevo, Džemala Bijedića 25c
tel./fax: 00387 33 407 935, 00387 33 407 939
e-mail: info@gemma.ba
www.gemma.ba

CROATIA / Gemma B&D d.o.o.

10000 Zagreb, Prisavlje 2 (Bočarski dom)
tel.: 00385 1 6 196 446, 6195 604, fax: 00385 1 6 195 581
e-mail: veleprodaja@gemma.hr
www.gemma.hr

HUNGARY / GEMMA B&D Kft.

2040 Budaörs, Puskás Tivadar út 14
Tel.: +36 23 769 245
e-mail: info@gemmabd.hu
www.gemmabd.hu

MONTENEGRO / Gemma B&D d.o.o.

10000 Zagreb, Prisavlje 2 (Bočarski dom)
tel.: 00385 1 6 196 446, 6195 604, fax: 00385 1 6 195 581
e-mail: veleprodaja@gemma.hr
www.gemmabd.me

SERBIA / Gemma B&D d.o.o.

11070 Novi Beograd, Đorđa Stanojevića 14
tel: 00381 11 2285 020, fax: 00381 11 3188 033
e-mail: info@gemma.rs
www.gemma.rs



HRVATSKA / Gemma B&D d.o.o.
10000 Zagreb, Prisavlje 2 (Boćarski dom)
Veleprodaja: tel.: +385 1 6196 446, 6195 604, fax: +385 1 6195 581, e-mail: veleprodaja@gemma.hr
Tehnička služba: tel/fax: +385 1 6195 582, e-mail: servis@gemma.hr
www.gemma.hr

BOSNA I HERCEGOVINA / Gemma BH d.o.o.
71000 Sarajevo, Džemala Bijedića 25c
tel./fax: +387 33 407 935, +387 33 407 939
e-mail: info@gemma.ba
www.gemma.ba

CRNA GORA / Gemma B&D d.o.o.
10000 Zagreb, Prisavlje 2 (Boćarski dom)
Veleprodaja: tel.: +385 1 6196 446, 6195 604, fax: +385 1 6195 581, e-mail: veleprodaja@gemma.hr
Tehnička služba: tel/fax: +385 1 6195 582, e-mail: servis@gemma.hr
www.gemmabd.me